

The 30  
Donghia  
Icons

# The 30 Donghia Icons

DONGHIA

A fine selection of furniture, lighting and accessories that contributed to define Donghia's signature look and elevate it to an icon of American design.

4

The Donghia Icons are pieces whose alluring silhouettes have contributed to the success of some of the world's most acclaimed interiors.

Masterpieces of upholstery that are finely tailored sculptures, rich in sophisticated details and full of sartorial charm. Well-thought proportions along with the best materials result in their legendary comfort, known to last for generations.

5

6



Time-honored techniques





8



9



Superior Craftmanship

10



11

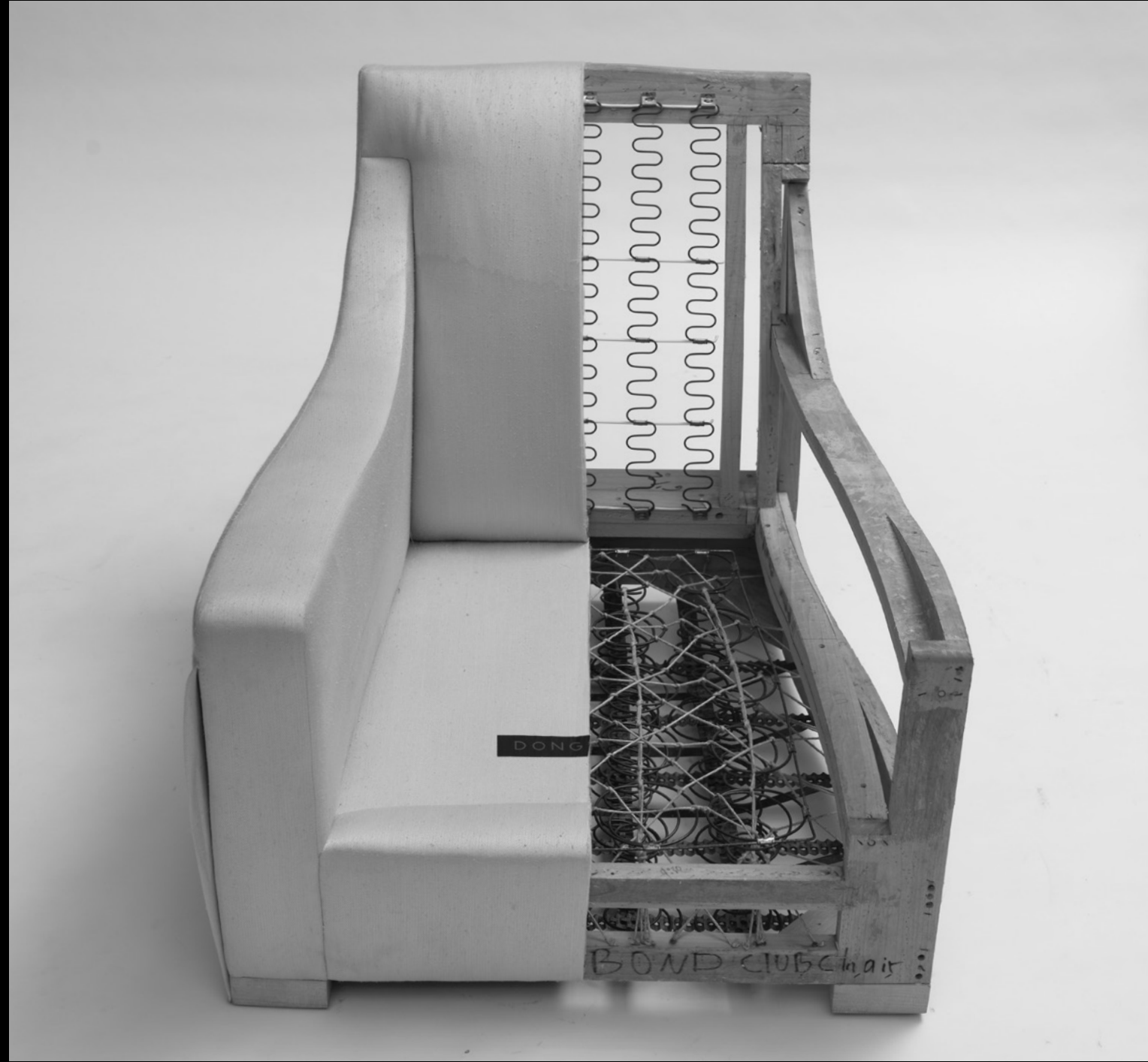





16 Donghia's iconic lighting and accessories are regarded as works of art for the mastery they require from craftsmen who create them in Murano, Italy.

Details familiar to connoisseurs of the trade, such as the twisted square section of the arms of Donghia's best known chandeliers, are the result of ancient and complex techniques that are closely guarded secrets.

17 In keeping with the legacy of its founder, Donghia believes that you should feel at all times that what is around you is attractive, and that you are attractive.



# Acadia End Table

18

19



Distinctly American in aesthetic, scale and functionality, the Acadia End Table is an outstanding showcase of fine metalwork. The wide, round glass top and a starburst-shaped walnut shelf offer plenty of usable surface, making this table a true staple for any living space.







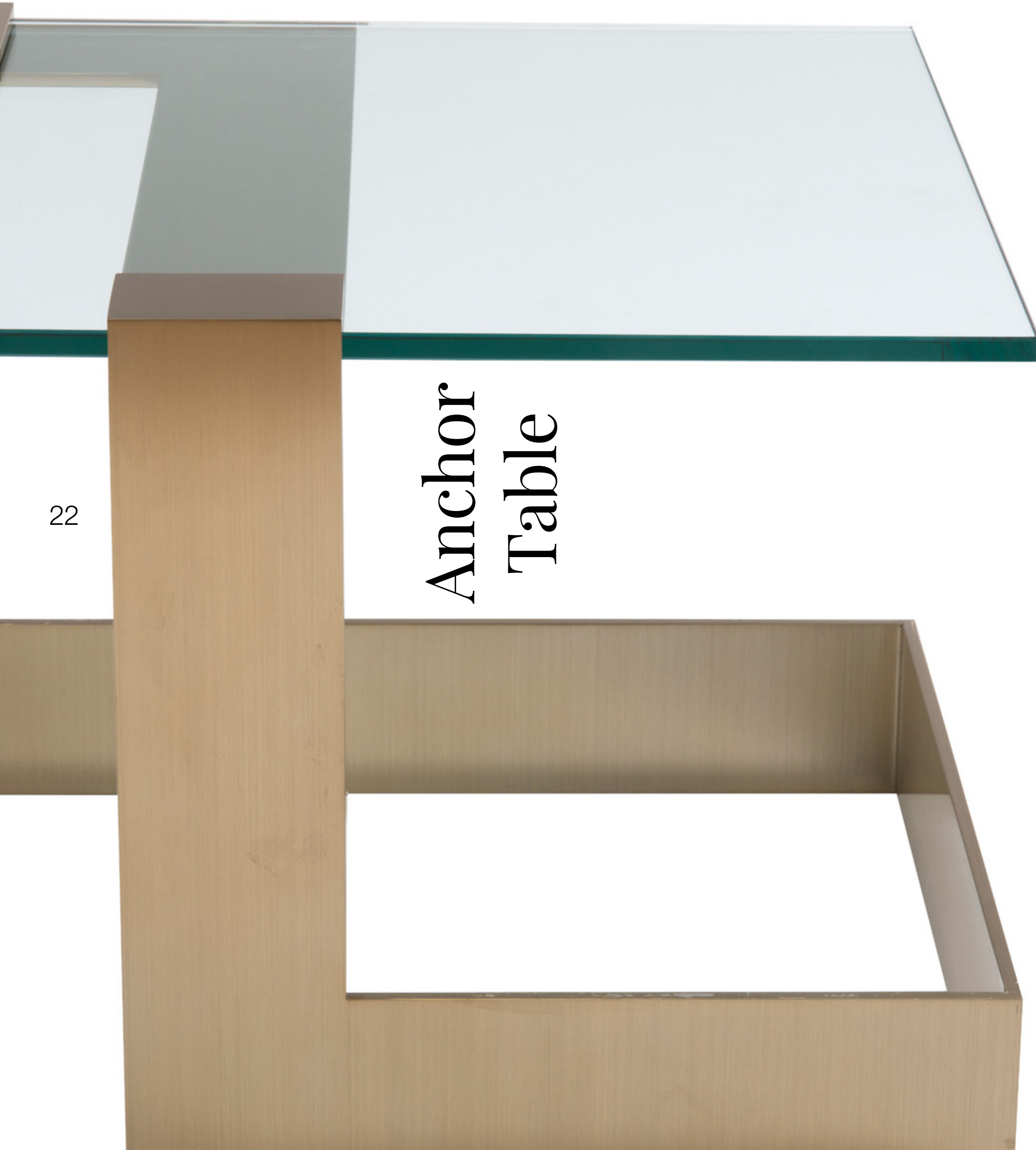

22

# Anchor Table

With a nod to the celebrated '70s urban style that is at the very root of the Donghia furniture brand, the Anchor table is a geometric and sophisticated design, composed of solid steel bases holding a glass top available in different sizes and colors.

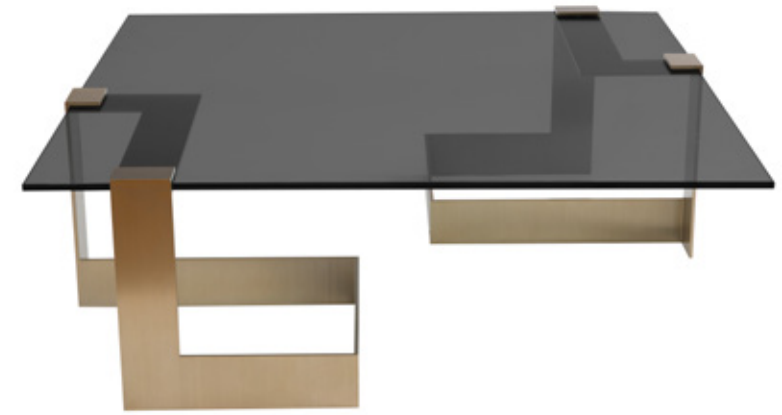

23



24

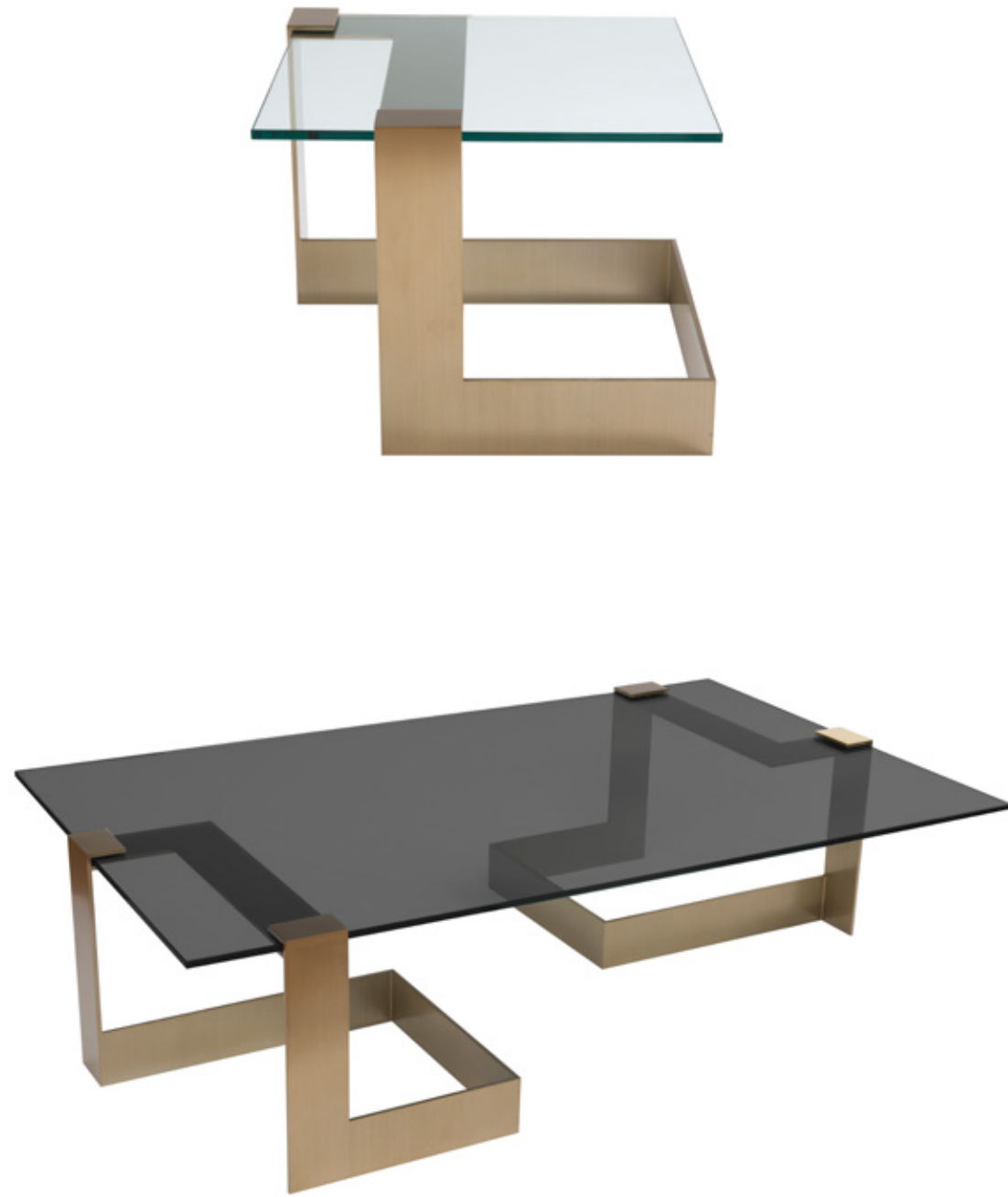

25



# Anziano Collection

26



27

John Hutton designed the stackable Anziano chair in 1989 for the American Academy of Rome, reinterpreting the silhouette of ancient Greek klismos chairs using a contemporary design language. The chair was introduced in 1991 into the Donghia line, quickly becoming an icon of American industrial design. The Anziano chair made his appearance in Hollywood movies and it is part of the permanent collection of the Brooklyn Museum. In 2018 the Anziano lineup was complemented by bar and counter height companions. These additions maintain the ingenious stackability, but also come with a 3-sided footrest for added comfort.



28

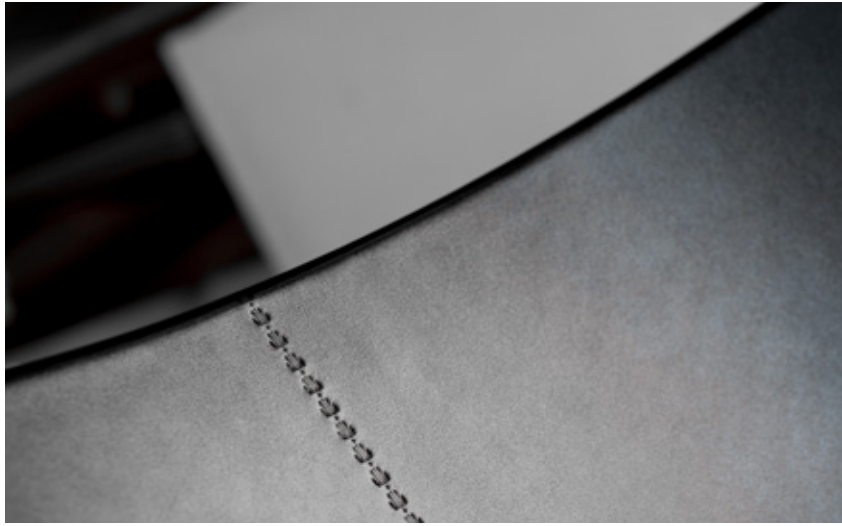

bar



counter



side



29





30



31



Collins is a highly unique cantilever end table, entirely made of bent wood with an optional stone insert. A design inspired by jewelry, Collins gracefully overlaps with a sofa, like a cuff bracelet would on a wrist. The scale and the shape of this piece allow for many different uses ranging from drink table, end table and sofa-desk for laptops.

32

# Collins Side Table

33





34



35





36



## Curve Sofa

37

Inspired by the works of mid-century Italian masters such as Ico Parisi, the Curve sofa is a glamorous and sculptural upholstery masterpiece. Looking gorgeous from all around, it easily gives a focal point to any room. The seat features a loose cushion that can accommodate three people comfortably and the curved, tight back offers plenty of support, making the Curve ideal for conversations. Comes standard with a metal plinth base available in multiple finishes.



38



39



40



41



# Cusp Mirror



42

Cusp is a medium-sized wall mirror with a distinct look given by its octagonal brass frame. Details such as the combination of polished and rubbed patina finishes can only be achieved by hand, and shows the mastery of skilled artisans, enabled to preserve this trade thanks to the unparalleled beauty of their creations.

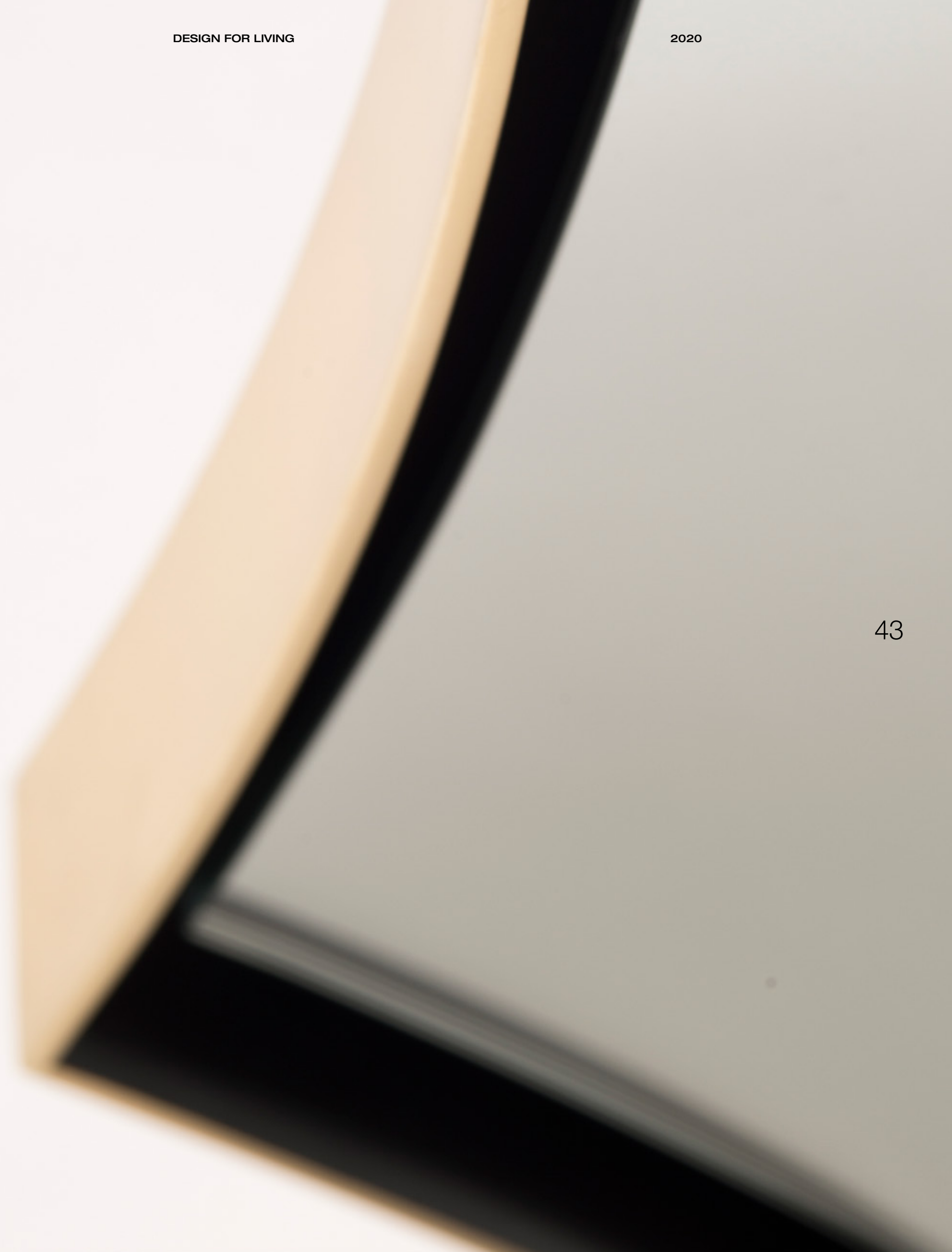

43







# Dee Chair



The Dee chair is the contemporary interpretation of the stark and masculine look of the early Donghia creations. The seat is suspended between light yet strong steel arms capped by walnut accents. It was conceived aiming for the ideal human-scale proportions, paying meticulous attention at how the different elements work together to result in the most desirable seat comfort.



# Druzy Lamp

A table lamp inspired by the whimsical beauty of natural Druzy crystals that form within rock fractures. Its unique look is achieved by a lengthy craft process that starts from blocks of matte, hand-poured Venetian glass, then stacked into a mineral-like formation and painted by hand. When lit, the glass body subtly diffuses the light through its interplay of countless facets and alluring negative spaces.



48

49







50

# Egos Lounge Chair



51



The Egos is a three-legged, partially upholstered lounge chair with a matching ottoman. Donghia's newest iteration of its signature klismos style brilliantly blends a nostalgia for edgy midcentury flair with an astonishing display of state-of-the-art woodworking. The impressive back leg and the sinuous stretchers are carved out of solid American walnut.



# Esha Collection



Inspired by abstract geometrical motifs, in each piece of the Esha collection the same solid glass blocks, hand-cast in Murano, are combined in a different pattern to convey from all angles a nuanced reflection of the light. The finishes are achieved by hand by incorporating special minerals within the glass during the casting process, giving to each block a unique appearance.



54



55

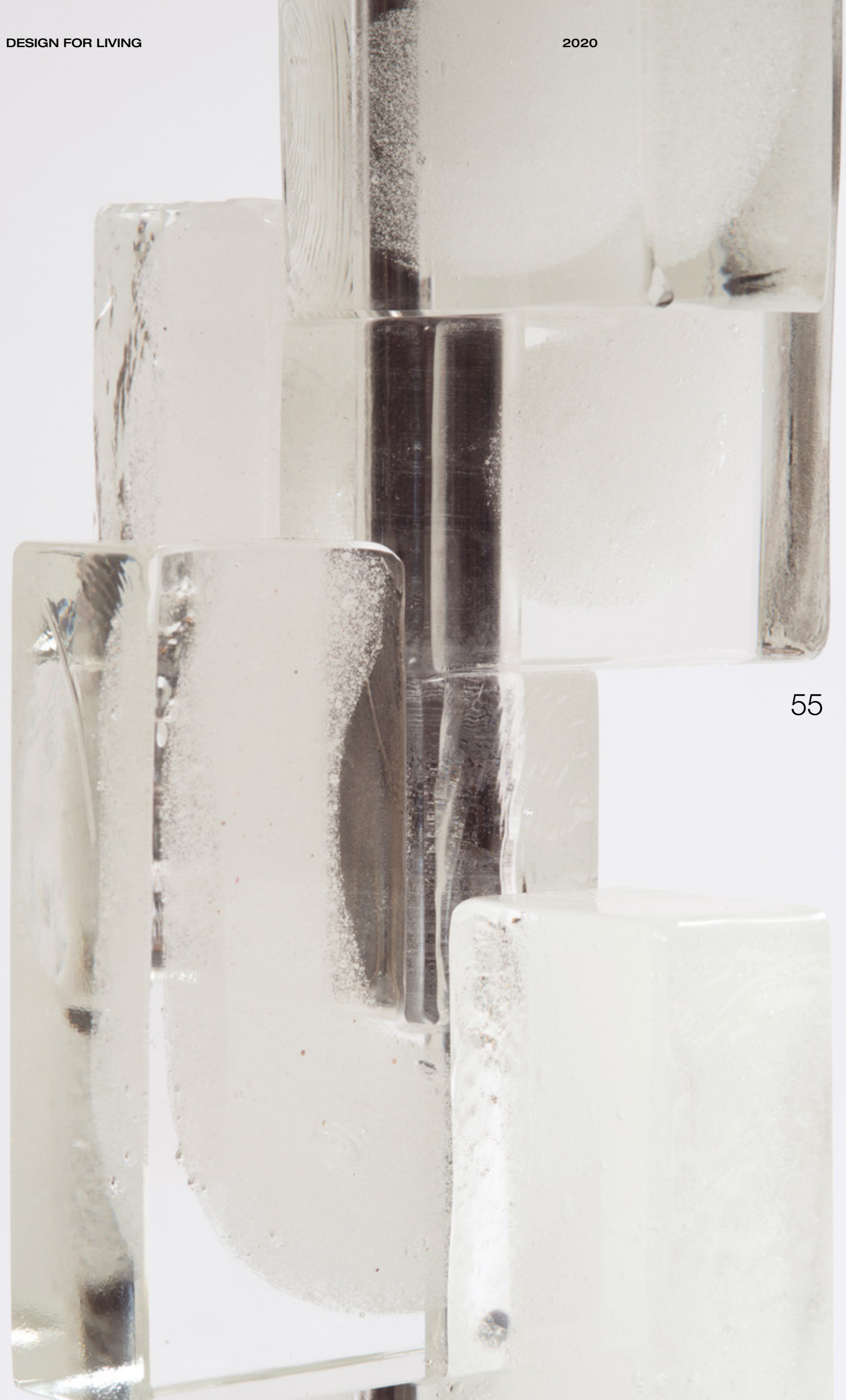



56



57



# Forma Table

The Forma table is designed to be a functional, playful and elegant addition to any living space; its eclectic yet clean aesthetic can tie it into virtually any style. The great scale and precious details make it the perfect occasional table while its unique, clever, hexagonal shape invites to play with multiples. Available with options of wooden or natural stone tops.

58

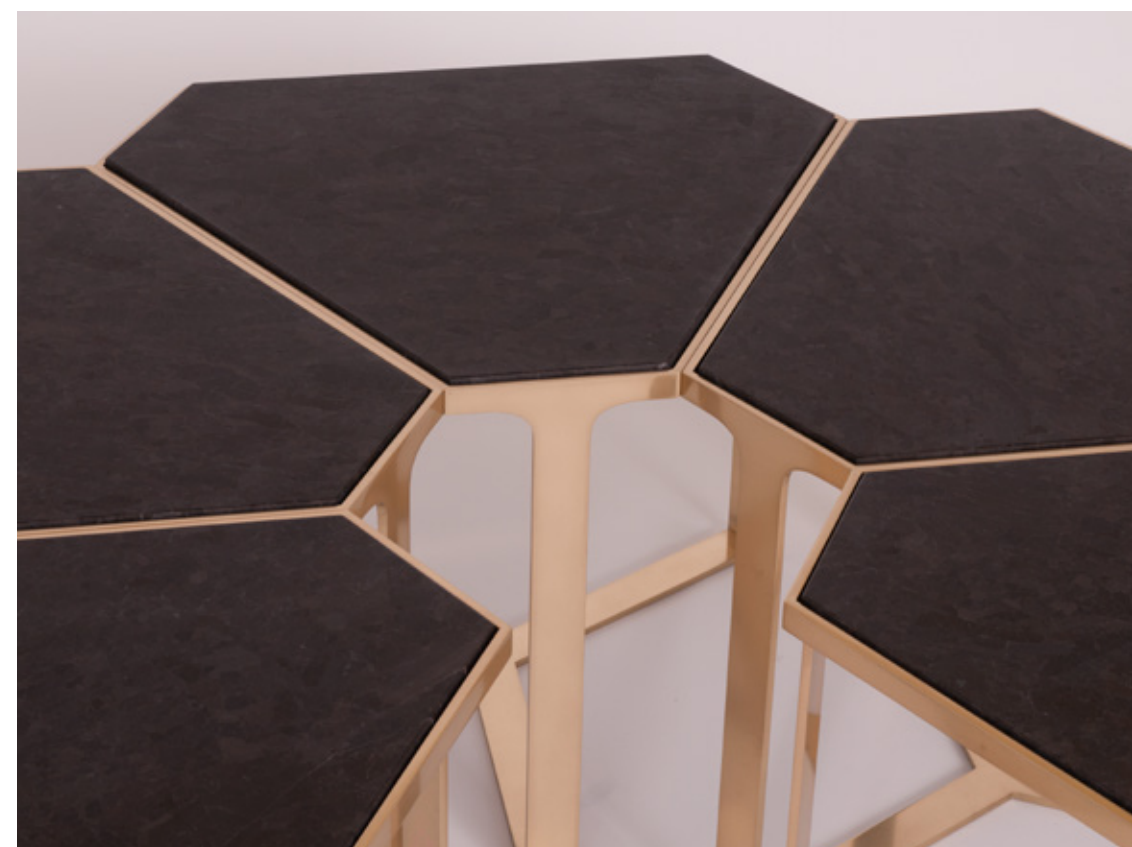

59





60

# Georgette Lounge Chair



2020

61

Refined and sumptuous, the Georgette Lounge Chair flows like its namesake fabric might on a dancer's costume. Drawing inspiration from Donghia classic designs, Georgette offers superb comfort and lasting quality in a very complex piece. The carved wood detail that frames the chair is its absolute highlight, and its refined finishes can tie this masterpiece into transitional as well as contemporary spaces. The Georgette comes standard on a wooden plinth base with option of swivel base available.



# Giselle Settee

62



63

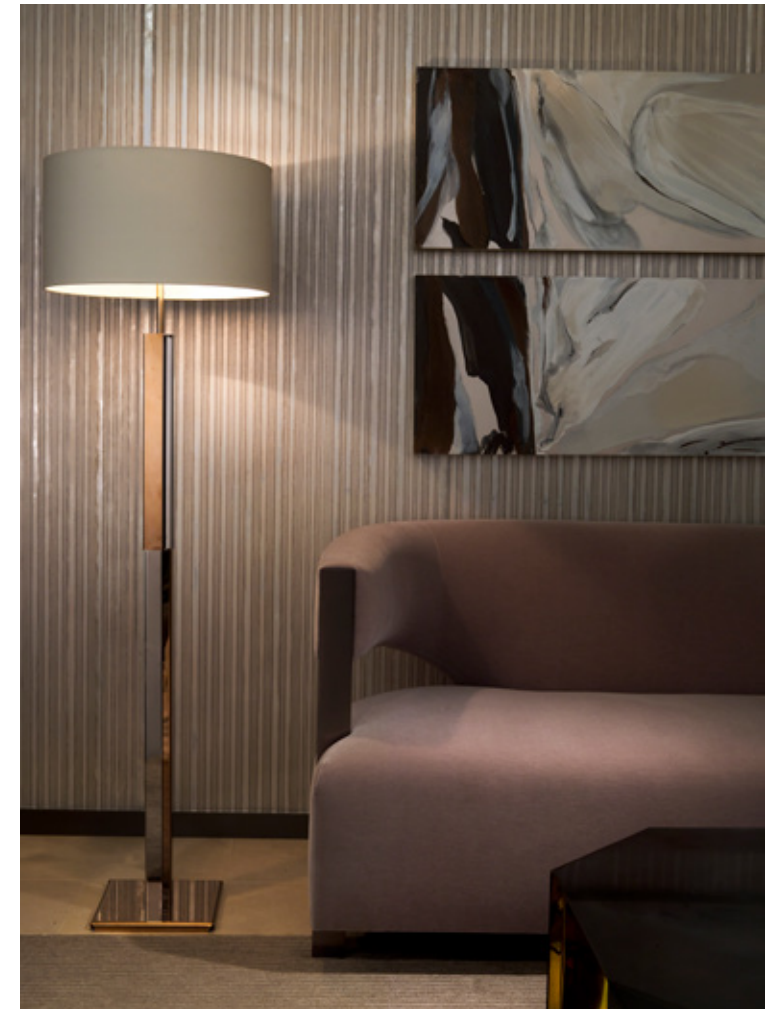

Drawing inspiration from the quintessential-ly Donghia klismos silhouette, the Giselle Settee is a striking ensemble of soft, gentle curves and bold geometric details, equally beautiful from all sides. Known to be a favorite of celebrities, with its sculptural look it certainly makes a statement as a compact sofa or as a floating accent piece.



64

# Island Collection

Originally designed in 2001 by Joe D'Urso for Donghia, the Island collection quickly became the cornerstone of the brand lineup. Eccentric and clever like the lifestyle it epitomizes, the shape and layout of this unique seat still defy all existing concepts of sofa. The tight seat and back are an impeccable display of the Donghia tailored look, with its combination of exact streamlines and soft details.



65



66



67







# Klismos Chair

The Klismos upholstered chair is Donghia's take on a neoclassical style whose origins can be traced back to ancient Greece: in many scenes painted on pottery gods and goddesses can be seen sitting on klismos chairs. Its elegant shape, with a curved back and splayed legs, makes a timeless and playful addition to any setting. Comes standard with or without nailheads.





# Lana Club Chair



Combining Klismos contours with 1950's Hollywood glamour, the Lana Chair has been a beloved part of the Donghia portfolio since 2012. Perfectly scaled for the human body, its curved back and arms make you feel hugged as you lounge in it, while its contemporary style with gentle curves and tailored details makes it a great fit for any space. The Lana comes standard on a wooden plinth base with option of swivel base available.





72



73



# Manhattan Sectional



74

75

Originally designed by Angelo Donghia for Ralph Lauren's 5th Avenue Apartment, the Manhattan Sofa is the most iconic of Donghia's furniture creations. With a design well beyond its time, it set a standard for the contemporary urban glamour aesthetic that lasts to this day. Wide, low, modular and extremely comfortable, the Manhattan is a piece that best represents the effortless elegance the brand is known for.





76



77



78



# Marchesa Mirror

79

Marchesa is one of Donghia's signature mirrors. Hand crafted in Murano using only the finest silvering, it strikes the balance between the ancient Venetian techniques and New York City's glamorous transitional aesthetic. Its large size and a thin tiled frame result in a greatly functional piece, with plenty of reflective surface.





80

# Noble Club Chair



81

The Noble is one of the best examples of the legendary comfort Donghia has been known for decades. A timeless, approachable and uncluttered design where good proportions, top tier materials and tailored upholstery make the show. The chair comes standard on wooden feet with option of swivel base available.

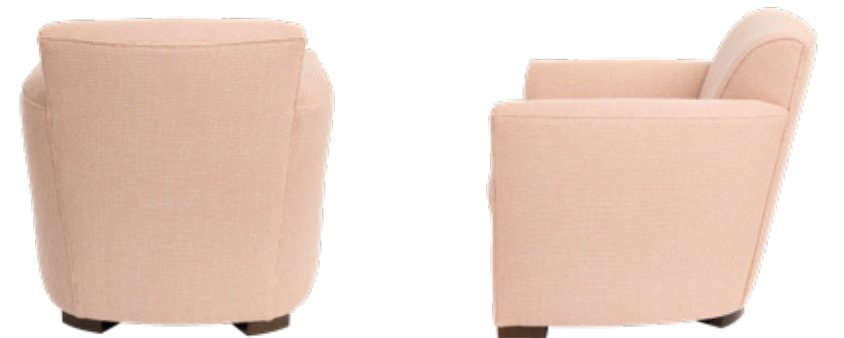



# Origami Collection

82



83

The Origami collection bears both the name and look of the traditional Japanese art of folding paper into objects. Donghia's Origami is achieved through a complex artisanal process of cutting, folding and welding a substantial metal foil into the final shape of a cocktail, occasional and console tables. Its true wonder is the reflective finish on the faceted inside, that creates an illusion of a kaleidoscope-like endless space enclosed into sharp geometrical boundaries.





84

85





86



87

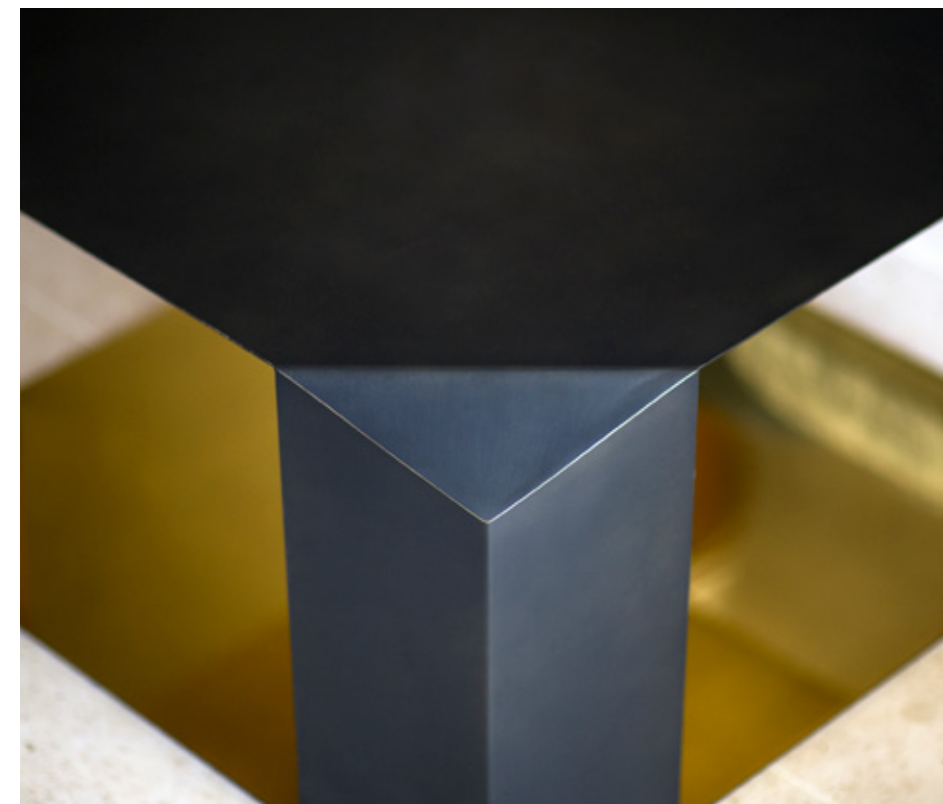

On this page:  
Origami console table





88



## Pavel Sofa

A bold, mid-century inspired contour and soft volumes define the highly unique Pavel sofa. Layered and sculpted lofts gracefully embrace the loose cushion seat, creating a comfortable and welcoming nest. A piece that exudes glamour and invites to party and conversations. Available in both sectional and three seater sofa configurations.

89





90



This hand-blown Venetian glass globe is multi-folded and meticulously finished, allowing the light striking the lamp to project at multiple angles like on a precious stone. Prong's brilliance is best captured in Donghia's blue agate; a clear glass with sweeps of grays and blues due to minerals added manually during the blowing process.

# Prong Table Lamp

91

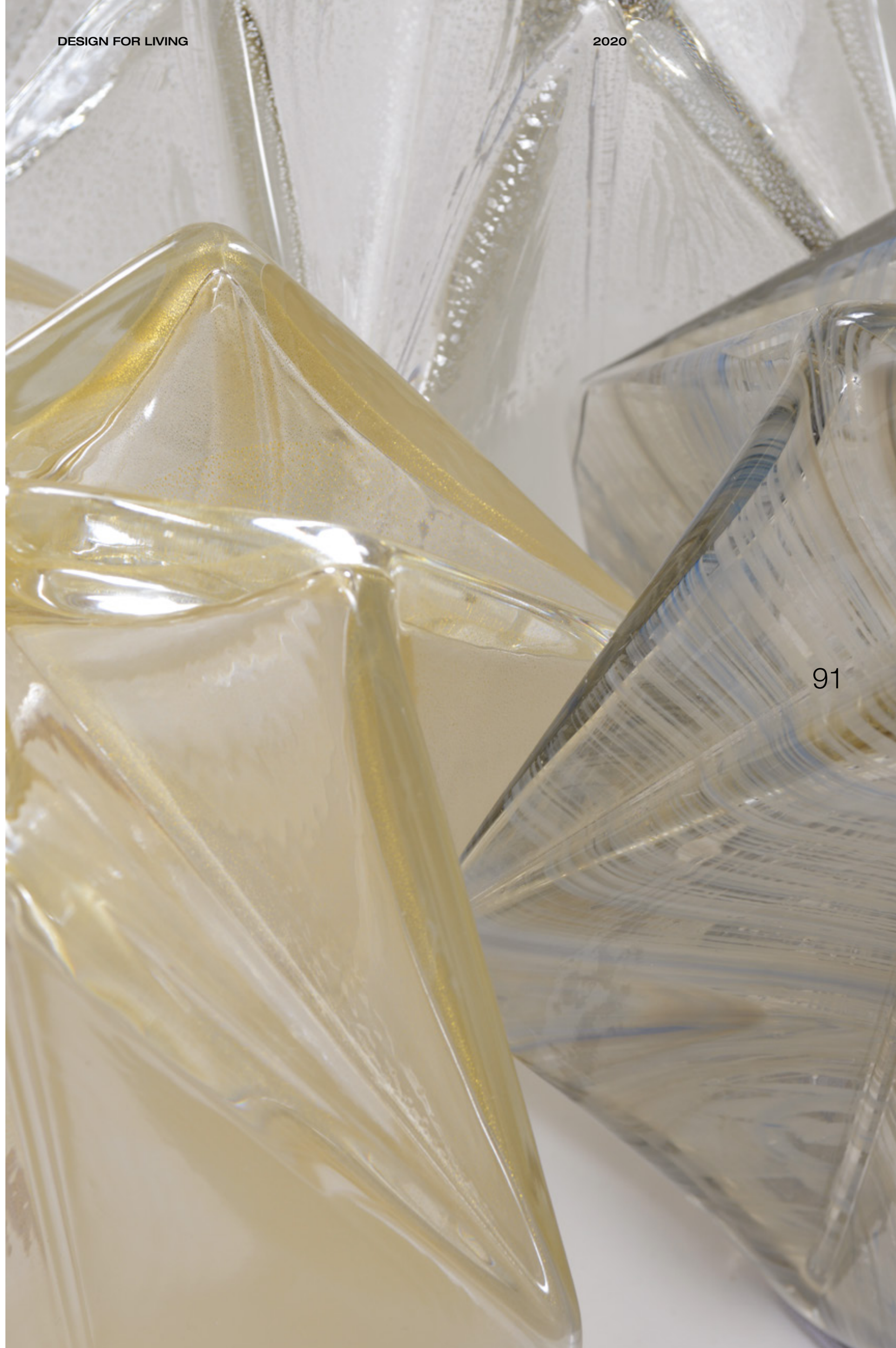





92

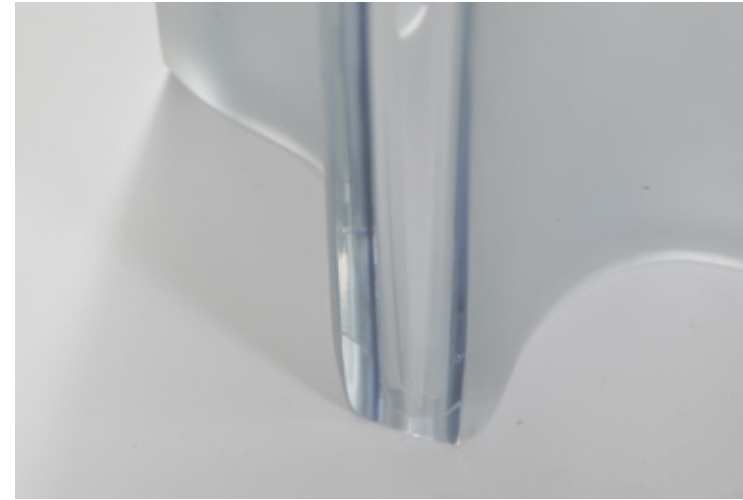

93

Crafted into a symmetrical shape from hand-blown glass, Quatrefoil's intriguing design is defined by the contrast between matte curved prongs and clear, flat surfaces. A clever and delicate form to showcase the multiple layers that make up the colored glass. The textures are produced by one of Murano's classical techniques called *nastratura*, each piece requires a high amount of finishing in the hand of a skilled craftsman.

# Quatrefoil Table Lamp





# Renaldo Collection

This award winner hand-blown glass chandelier epitomizes the 70's chic lifestyle and look that Angelo Donghia was known for and that remains part of the Donghia DNA. The wide range of finish combinations and sizes, balanced proportions and impeccable details allow Renaldo to serve as striking design statement in a contemporary setting or subtle accent for a sumptuous room.



96



97



98



# Riverside Sectional



Named after Riverside Park in the Upper West Side of Manhattan, Riverside is a rounded Sectional Sofa designed for today's lifestyle. Its deep and low seat is designed for lounging with the best possible comfort. This sofa is a floating upholstered sculpture capable of defining the home space in endless ways thanks to its many possible iterations: the Riverside sections can be easily swapped, moved, turned, and even used to make tête-à-tête type of seats.

99







100



101







102



In this long-time Donghia icon the dramatic, sinuous silhouette mimics the shape of a marine shell. The seat is embraced by a tight, tailored back, crafted with the most traditional upholstery techniques, resulting in the unmatched quality, comfort and graceful aesthetic that made this piece a favorite over several decades.

103

# Shell Chair





104



105



# Stellare Collection



Stellare, as the most iconic heirloom of Donghia's glamorous '80s, is regarded as the emblem of the entire Donghia lighting collection and one of the most significant statements of the brand's style. Up to this day, only one well-respected glass shop in Murano is capable of crafting the stunning twisted square section that makes Donghia chandeliers so unique.



106

# Stone Mirrors



107

Inspired by the shape of monoliths and modern abstract art, is a set of handmade wall mirrors with handmade antiqued silvering and wide beveled edge details, with all the charm of an authentic piece of art. The large mirror has a light antiqued finish and the the small mirror has a dark antiqued finish, and they are both crafted in Murano, Italy.



108



109



Inspired by the namesake stone, Tourmaline showcases a gradient of handmade solid Murano glass blocks. This sophisticated table lamp ranges in colors of smoky topaz, gold, brown, indigo and slate. A dreamy artwork consisting of six blocks in graduating shades, the colors are produced with a special formula unique to this piece and may present small variations from batch to batch.



110



111

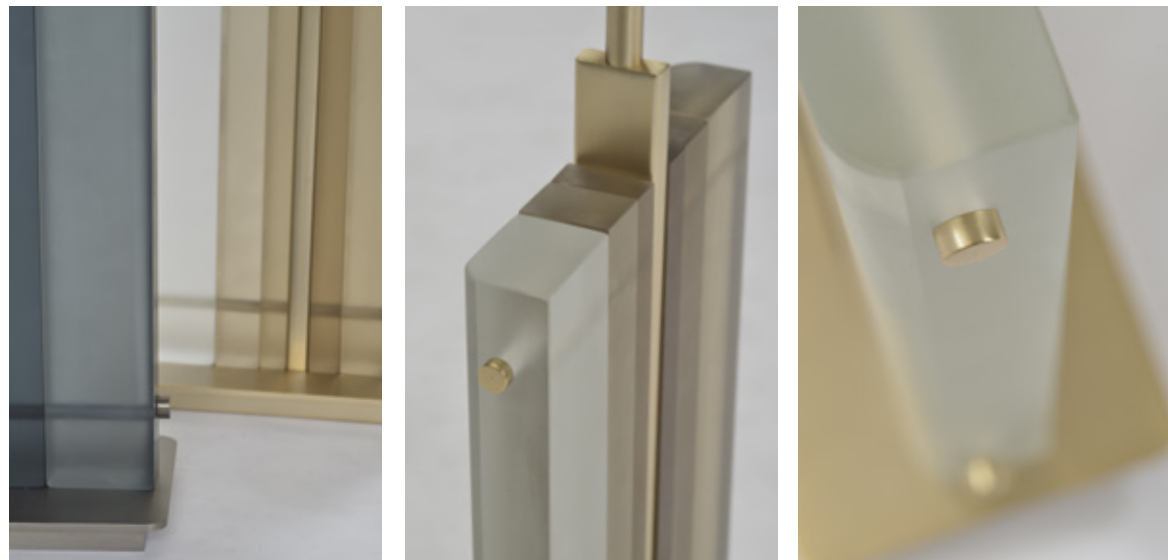

# Tourmaline Table Lamp





112

# Trillion Collection



113

With a concept inspired by the Trillion diamond cut, the sophisticated, fully upholstered back of the Trillion chairs has the shape of three smooth petals, embracing an open detail framed by a cord welt and solid maple legs. Its comfort is only as striking as its delicate beauty. Trillion is available as a side chair, counter chair, and bar stool.





The finest materials  
tailored with unrelenting  
attention to detail



# Index

## Products

05 SEATING

Anziano Collection, Curve Sofa, Dee Lounge Chair and Ottoman, Egos Lounge Chair and Ottoman, Georgette Lounge Chair, Giselle Settee, Island Collection, Klismos Upholstered Chair, Lana Club Chair, Manhattan Sectional Sofa, Noble Club Chair, Pavel Sofa, Pavel Sectional Sofa, Riverside Sectional Sofa, Shell Club Chair and Ottoman, Trillion Collection

17 TABLES

Acadia, Anchor, Collins, Forma, Origami Collection

20 LIGHTING & ACCESSORIES

Cusp Mirror, Druzy Lamp, Esha Collection, Marchesa Mirror, Prong Lamp, Quatrefoil Lamp, Renaldo Collection, Stellare Collection, Stone Mirrors, Tourmaline Lamp

## Finishings

26 Wood

28 Metal, Stone, Glass & Leather

30 Lighting & Accessories



# Seating

## Anziano 90001 *Bar Chair*

P. 26



WIDTH 20" / 51CM  
DEPTH 20.5" / 52CM  
HEIGHT 44" / 112CM  
SEAT HEIGHT 30.25" / 77CM



## Anziano 90002 *Side Chair*

P. 26



WIDTH 20" / 51CM  
DEPTH 20.5" / 52CM  
HEIGHT 32.25" / 82CM  
SEAT HEIGHT 18" / 46CM



## Curve 50678 *Sofa*

P. 37



WIDTH 100" / 254CM  
DEPTH 52.5" / 133CM  
HEIGHT 35" / 89CM  
SEAT HEIGHT 18" / 46CM



## Anziano 90000 *Counter Chair*

P. 26



WIDTH 20" / 51CM  
DEPTH 20.5" / 52CM  
HEIGHT 38" / 97CM  
SEAT HEIGHT 24.25" / 62CM



## Dee 50680 *Lounge Chair*

P. 46



WIDTH 30.25" / 77CM  
DEPTH 36" / 91CM  
HEIGHT 33" / 84CM  
SEAT HEIGHT 18" / 46CM







**Dee** 50679  
*Ottoman*

P. 46

WIDTH 24" / 61CM  
DEPTH 22.5" / 57CM  
HEIGHT H17.5" / 44CM

Brushed  
Smoke



212



**Georgette** 50781  
*Lounge Chair*

P. 60

WIDTH 29.5" / 75CM  
DEPTH 34" / 86CM  
HEIGHT 36.5" / 93CM  
SEAT HEIGHT 17" / 43CM  
ARM HEIGHT 24" / 61CM

*Additional option: swivel base*

Heater  
Mahogany



022

Warm  
Cherry  
Mahogany



026

Black  
Cherry  
Mahogany



027



**Egos** 50695  
*Lounge Chair*

P. 51

WIDTH 30" / 76CM  
DEPTH 31" / 79 CM  
HEIGHT 31" / 79CM  
SEAT HEIGHT 18" / 46CM

Grey  
Walnut



013

Cognac  
Walnut



016

Mink  
Walnut



018

Warm  
Smoke



202

Brushed  
Bronze



214



**Giselle** 50801  
*Settee*

P. 62

WIDTH 66.5" / 169CM  
DEPTH 32.75" / 83CM  
HEIGHT 32.25" / 82CM  
SEAT HEIGHT 18.25" / 46CM  
ARM HEIGHT 31" / 79CM

Warm  
Smoke



202



**Egos** 50694  
*Ottoman*

P. 51

WIDTH 26.5" / 67CM  
DEPTH 18" / 46CM  
HEIGHT 17.5" / 44CM

Grey  
Walnut



013

Cognac  
Walnut



016

Mink  
Walnut



018



**Island** 60018  
*Sofa*

P. 64

WIDTH 100.5" / 255CM  
DEPTH 48" / 122CM  
HEIGHT 30.5" / 77CM  
SEAT HEIGHT 16" / 41CM  
ARM HEIGHT 30.5" / 77CM

Natural  
Maple



001

Premium  
Smoke  
Grey Maple



003

Warm  
Cherry  
Maple



006

Brown  
Mahogany  
Maple



008

Ebonized  
Maple



009



**Island Petite** 60023  
*Sofa*

P. 64



WIDTH 82.5" / 210CM  
DEPTH 43" / 109CM  
HEIGHT 30.5" / 77CM  
SEAT HEIGHT 16" / 41CM  
ARM HEIGHT 30.5" / 77CM



**Manhattan Sectional** 50723  
*Corner Section*

P. 74



WIDTH 42' / 107CM  
DEPTH 42' / 107CM  
HEIGHT 28.5" / 72CM  
SEAT HEIGHT 17" / 43CM



**Klismos Upholstered** 07051  
*Occasional Chair*

P. 68



WIDTH 22" / 56CM  
DEPTH 26" / 66CM  
HEIGHT 30" / 76CM  
SEAT HEIGHT 16.5" / 42CM



**Manhattan Sectional** 50722  
*Armless Section*

P. 74



WIDTH 42" / 122CM  
DEPTH 42" / 107CM  
HEIGHT 28.5" / 72CM  
SEAT HEIGHT 17" / 43CM



**Lana** 50550  
*Club Chair*

P. 70



WIDTH 31.25" / 79CM  
DEPTH 31.5" / 80CM  
HEIGHT 30" / 76CM  
SEAT HEIGHT 17" / 43CM  
ARM HEIGHT 25.5" / 65CM

*Additional option: swivel base*



**Manhattan Sectional** 50724  
*Chaise*

P. 74



WIDTH 42" / 107CM  
DEPTH 84" / 213CM  
HEIGHT 28.5" / 72CM  
SEAT HEIGHT 17" / 43CM





**Manhattan Sectional** 50721  
*Ottoman*

P. 74



WIDTH 42" / 107CM  
DEPTH 42" / 107CM  
HEIGHT 17" / 43CM

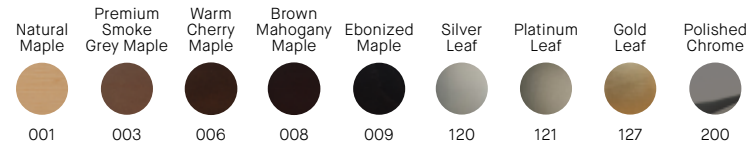

**Pavel Sectional** 50791  
*Armless Section*

P. 88



WIDTH 52.25" / 133CM  
DEPTH 34.5" / 88CM  
HEIGHT 31" / 79CM  
SEAT HEIGHT 18.5" / 47CM



**Noble** 04641  
*Club Chair*

P. 80



WIDTH 30.5" / 77CM  
DEPTH 35" / 89CM  
HEIGHT 31.5" / 80CM  
SEAT HEIGHT 16.5" / 42CM  
ARM HEIGHT 24" / 61CM

*Alternative option: swivel base instead of finished feet*



**Pavel Sectional** 50792  
*Corner Section*

P. 88



WIDTH 34.5" / 88CM  
DEPTH 34.5" / 88CM  
HEIGHT 31" / 79CM  
SEAT HEIGHT 18.5" / 47CM



**Pavel** 50795  
*Sofa*

P. 88



WIDTH 96" / 244CM  
DEPTH 34.5" / 88CM  
HEIGHT 31" / 79CM  
SEAT HEIGHT 18.5" / 47CM



**Pavel Sectional** 50793  
*End Section*

P. 88



WIDTH 33.5" / 85CM  
DEPTH 34.5" / 88CM  
HEIGHT 31" / 79CM  
SEAT HEIGHT 18.5" / 47CM  
ARM HEIGHT 26" / 66CM





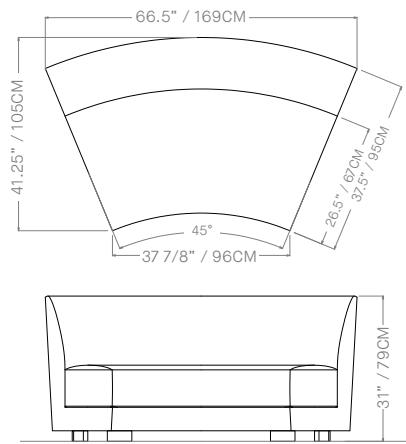

**Riverside Sectional** 50712  
*Armless Concave Section*

WIDTH 66.5" / 169CM  
DEPTH 41.25" / 105CM  
HEIGHT 31" / 79CM  
SEAT HEIGHT 16.25" / 41CM

P. 98

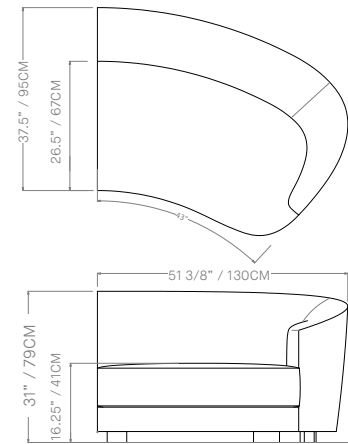

**Riverside Sectional** 50715  
*End Section*

WIDTH 56.5" / 144CM  
DEPTH 39.5" / 100CM  
HEIGHT 31" / 79CM  
SEAT HEIGHT 16.25" / 41CM

P. 98

13

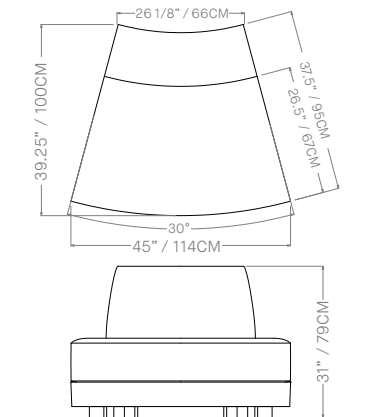

**Riverside Sectional** 50713  
*Armless Convex Section*

WIDTH 45" / 114CM  
DEPTH 39.25" / 100CM  
HEIGHT 31" / 79CM  
SEAT HEIGHT 16.25" / 41CM

P. 98



**Shell** 2441  
*Club Chair*

WIDTH 32.5" / 82CM  
DEPTH 36.5" / 93CM  
HEIGHT 34.5" / 88CM  
SEAT HEIGHT 16.5" / 42CM  
ARM HEIGHT 23.5" / 60CM

P. 102

14



**Riverside Sectional** 50714  
*Backless Section*

WIDTH 45" / 114CM  
DEPTH 36" / 91CM  
HEIGHT 16.3" / 41CM

P. 98

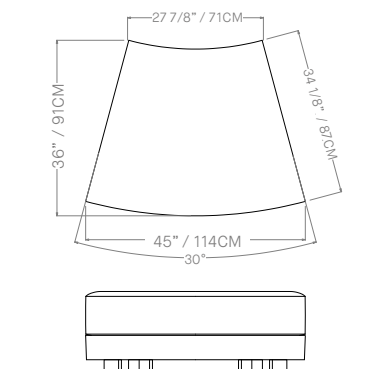

**Shell** 2440  
*Ottoman*

WIDTH 26.5" / 67CM  
DEPTH 18" / 46CM  
HEIGHT 16" / 41CM

P. 102





**Trillion** 50671  
*Side Chair*

P. 113



WIDTH 23.25" / 59CM  
DEPTH 22.25" / 57CM  
HEIGHT 31.25" / 79CM  
SEAT HEIGHT 19" / 48CM

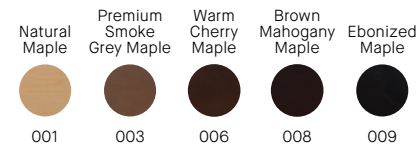

**Trillion** 50672  
*Counter Chair*

P. 113



WIDTH 22.75" / 58CM  
DEPTH 21.75" / 55CM  
HEIGHT 37.75" / 96CM  
SEAT HEIGHT 22.5" / 65CM

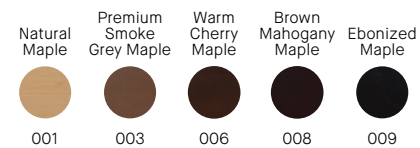

**Trillion** 50673  
*Bar Chair*

P. 113



WIDTH 22.75" / 58CM  
DEPTH 21.75" / 55CM  
HEIGHT 43.75" / 111CM  
SEAT HEIGHT 31.5" / 80CM

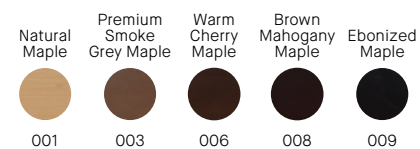

# Tables

**Acadia** 60361  
*End Table*

P. 18



WIDTH 28" / 71CM  
HEIGHT 26" / 66CM  
DEPTH 26" / 66CM  
DIAMETER 28" / 71CM



**Anchor** 68251  
*Cocktail Table*

P. 22



WIDTH 60" / 152CM  
DEPTH 36" / 91CM  
HEIGHT 16.5" / 42CM

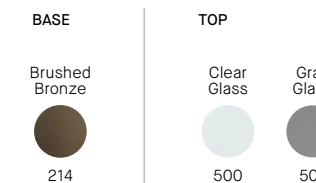







**Anchor 68250**  
*Occasional Table*

P. 22

WIDTH 21" / 55CM  
DEPTH 21" / 55CM  
HEIGHT 16.5" / 42CM

BASE		TOP	
Brushed Bronze		Clear Glass	Gray Glass
			
214		500	501

**Origami 60810**  
*Occasional Table*

P. 82



WIDTH 18" / 46CM  
DEPTH 18" / 46CM  
HEIGHT 20" / 51CM

Patinated / Polished Brass



236

**Collins 60823**  
*Occasional Table*

P. 32



WIDTH 24.5" / 62CM  
DEPTH 16" / 40CM  
HEIGHT 24.5" / 62CM

Natural Walnut	Crema Marfil Top
	
011	601

**Origami 60814**  
*Cocktail Table*

P. 82



WIDTH 30" / 76CM  
DEPTH 30" / 76CM  
HEIGHT 15.75" / 40CM

Patinated / Polished Brass



236







**Forma 68200**  
*Occasional Table*

P. 56



WIDTH 22.5" / 57CM  
DEPTH 19.5" / 50CM  
HEIGHT 17" / 43CM

*Shown with Chrome base and Grey glass top*

BASE		TOP			
Polished Chrome	Matte Brass	Grey Zebbrano	Gray Glass	Elegant Brown Stone	Brown Antique
					
200	226	063	501	605	609

**Origami 60812**  
*Console Table*

P. 82



WIDTH 72" / 183CM  
DEPTH 18" / 46CM  
HEIGHT 30" / 76CM

Patinated / Polished Brass



236



# Lighting & Accessories



**Esha Floor** 80086  
*Floor Lamp*

WIDTH 10" / 25CM  
DEPTH 8" / 20CM  
HEIGHT 60.5" / 154CM

*Shown in Ice*

**Suggested shades**  
Cylindrical shade 18 in 80032  
Rectangular shade large 80082



P. 53



**Druzy** 80098  
*Table Lamp*

WIDTH 5" / 13CM  
DEPTH 5" / 13CM  
HEIGHT 25.5" / 64CM

**Suggested shades**  
Square shade small 80105  
Cylindrical shade 16 in 80051

Light &  
Smoke Grey  
Matte Glass



P. 49



**Prong** 80096  
*Table Lamp*

DIAMETER 12.5" / 32CM  
HEIGHT 20.5" / 52CM

*Shown in Blue Agate*

**Suggested shades**  
Cylindrical shade 16 in 80051  
Small drum shade 80021



P. 90



**Esha Alta** 80085  
*Table Lamp*

WIDTH 7.25" / 18CM  
DEPTH 7.25" / 18CM  
HEIGHT 32.25" / 82CM

*Shown in Gold Dust*

**Suggested shades**  
rectangular shade small 80081



P. 53



**Quatrefoil Satin** 80093  
*Table Lamp*

WIDTH 6" / 15CM  
DEPTH 6" / 15CM  
HEIGHT 28.5" / 72CM

*Shown in Rose*

**Suggested shades**  
Cylindrical shade 16 in 80051  
Small drum shade 80021



P. 92

19

20





## Renaldo 12 Arm <sup>80400</sup> *Chandelier*

P. 94

DIAMETER 39.5" / 100CM  
HEIGHT 38" / 97CM

*shown in champagne*



## Stellare Grande <sup>80029</sup> *Chandelier*

P. 104

DIAMETER 60" / 152CM  
HEIGHT 58" / 147CM

**Suggested shades**  
Chandelier drum shade 80062

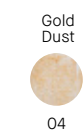

## Renaldo 18 Arm <sup>80500</sup> *Chandelier*

P. 94

DIAMETER 52.5" / 133CM  
HEIGHT 38" / 97CM

*shown in champagne*



## Stellare Tall <sup>80002</sup> *Chandelier*

P. 104

DIAMETER 47.5" / 121CM  
HEIGHT 45.5" / 116CM

**Suggested shades**  
Chandelier drum shade 80062

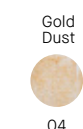

## Renaldo 3 Arm <sup>80097</sup> *Sconce*

P. 94

WIDTH 20.5" / 52CM  
DEPTH 14" / 36CM  
HEIGHT 16.5" / 42CM



## Stellare <sup>80030</sup> *Sconce*

P. 104

WIDTH 24" / 61CM  
DEPTH 10" / 25CM  
HEIGHT 18.5" / 47CM

**Suggested shades**  
Piccolo/sconce drum shade 80063

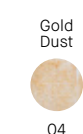





**Tourmaline** 80094  
*Table Lamp*

WIDTH 10.25" / 26CM  
DEPTH 5.5" / 14CM  
HEIGHT 25.75" / 65CM

*Shown in Topaz*

**Suggested shades**  
rounded rectangular shade small 80099



P. 110



**Stone (Pair)** 83650  
*Mirror*

WIDTH 39" / 99CM  
DEPTH 2.5" / 6CM  
HEIGHT 66" / 168CM



P. 106



**Cusp** 08350  
*Mirror*

WIDTH 32" / 81CM  
DEPTH 1.75" / 4CM  
HEIGHT 32" / 81CM

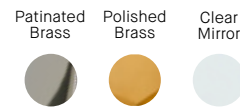

P. 42



**Marchesa** 08348  
*Mirror*

WIDTH 36.25" / 92CM  
DEPTH 55" / 140CM

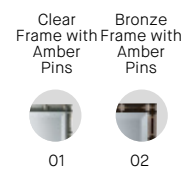

P. 78



# Wood

▲ PREMIUM FINISH

## Maple



NATURAL 001

SMOKE GRAY 003 ▲

WARM CHERRY 006



BROWN MAHOGANY 008

EBONIZED 009

## Metal Leaf

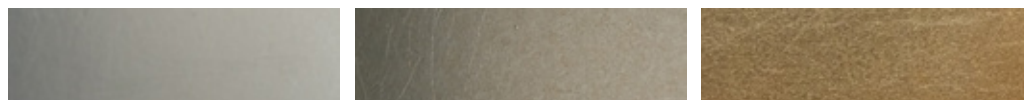

SILVER 120 ▲

PLATINUM 121 ▲

GOLD 127 ▲

## Walnut

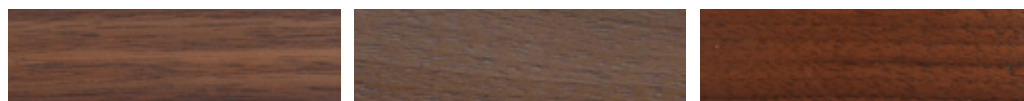

NATURAL 011

GRAY 013

COGNAC 016



MINK 018

## Mahogany



HEATHER 022 ▲

WARM CHERRY 026

BLACK CHERRY 027

## Anziano Beechwood



BROWN MAHOGANY 008

NATURAL WALNUT 011

## Anziano Leather

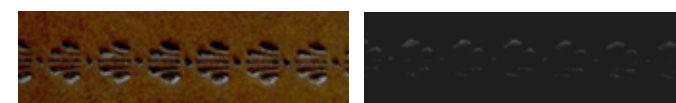

COGNAC 826

MIDNIGHT 829

## Zebrano

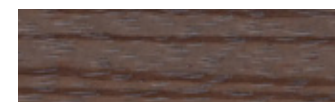

GRAY 063

## Camel Pau Ferro



043



# Furniture: Metal, Stone, Glass & Leather

## Metal

---

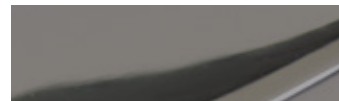

POLISHED CHROME 200



WARM SMOKE 202

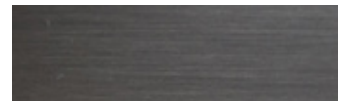

BRUSHED PEWTER 211

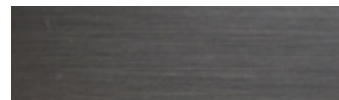

BRUSHED SMOKE 212



BRUSHED BRONZE 214



BRUSHED GOLD 217

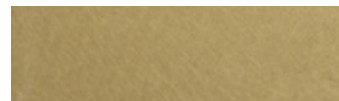

MATTE BRASS 226

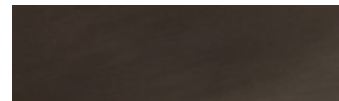

HANDRUBBED PATINA BRONZE 234

## Origami

---



PATINATED/POLISHED BRASS 236

## Glass

---

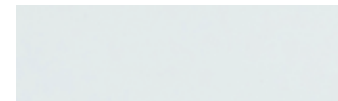

CLEAR 500



GRAY 501

## Stone

---



CREMA MARFIL 601



ELEGANT BROWN 605



BROWN ANTIQUE 609



# Lighting & Accessories

## Murano & Venetian Glass

---



ESHA GOLD DUST 01



QUATREFOIL SATIN ROSE 01



TOURMALINE TOPAZ 01



ESHA ICE 02



QUATREFOIL SATIN PERIWINKLE 02



TOURMALINE SLATE 02



PRONG GOLD DUST 01



PRONG SILVER DUST 02

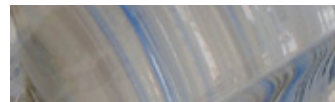

PRONG BLUE AGATE 03



STELLARE GOLD DUST 04

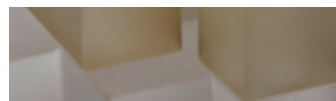

DRUZY MATTE LIGHT AND SMOKE GREY 01



MARCHESA CLEAR, AMBER PINS 01



MARCHESA BRONZE, AMBER PINS 02



STONE ANTIQUED CLEAR 01

## Metal

---

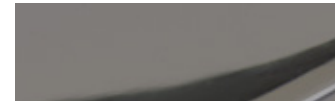

POLISHED CHROME 200

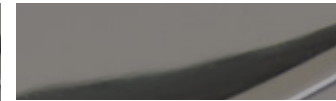

POLISHED BLACK CHROME 203

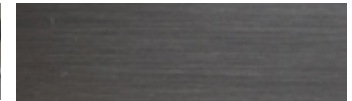

BRUSHED SMOKE 212



BRUSHED GOLD 217

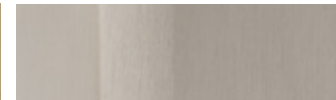

BRUSHED NICKEL 221

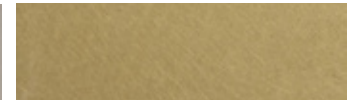

MATTE BRASS 226



**Art Direction  
& Graphic Design**  
Eleonora Papini  
mormorcreative.com

**Photographers**  
Dan Root  
Gabriele Rosina  
Andrew Bordwin  
Cuba Studio  
Mayo Studios



