

Update 2



Update 2

Values of Design

it — Cura, qualità produttiva, cultura industriale e progettuale come valori aziendali fondanti: è l'identità di Desalto, quel filo conduttore rigoroso che accompagna da sempre ogni prodotto della collezione. Un catalogo che si arricchisce con attenzione, grazie a una selezione ragionata di arredi disegnati da progettisti di valore: prodotti raffinati e versatili, realizzati con sapiente maestria, dai dettagli attenti e inaspettati.

Tre i nuovi prodotti, tra sfida progettuale, rigore estetico e aggiornamento tecnologico: un tavolo allungabile in equilibrio perfetto tra forma e funzione, di Gordon Guillaumier; un mobile contenitore modulare dalla forte matericità, di Giacomo Moor; una famiglia di tavoli e tavolini che trova nella geometria della costruzione il suo segno distintivo, di Guglielmo Poletti.

en — Care, production quality, industrial and design culture as founding corporate values: this is the identity of Desalto, that rigorous common thread always running through each product in the collection. A catalogue that is enriched thoughtfully, thanks to a deliberate selection of furnishings created by eminent designers – refined, versatile products, made with skilful craftsmanship, with careful and unexpected details. There are three new products, showcasing design challenge, aesthetic rigour and state-of-the-art technology: an extendable table with perfect balance between form and function, by Gordon Guillaumier; a modular storage unit with strong materiality, by Giacomo

Moor; a family of tables and small tables where the geometry of construction becomes its identifying feature, by Guglielmo Poletti.

de — Sorgfalt, hochwertige Produktion und Industrie- und Designkultur sind die grundsätzlichen Werte der Identität von Desalto und von Anfang an gemeinsamer Nenner aller Produkte unserer Kollektion. Unser Katalog erweitert sich langsam. Mit überlegter Sorgfalt werden Einrichtungsstücke bewährter Designer ausgewählt: exklusive, anpassungsfähige Produkte, mit großem Geschick gefertigt, aufmerksam und überraschend in den Details. Die drei neuen Produkte sind eine Herausforderung für den Designer, von ästhetischer Konsequenz und modern in der Technik: ein Ausziehtisch, in dem Form und Funktion harmonisch verschmelzen, von Gordon Guillaumier; ein modulares Schrankmöbel von starker Stofflichkeit, von Giacomo Moor; eine Linie aus großen und kleinen Tischen, die in der Geometrie ihrer Konstruktion das charakteristische Merkmal haben, von Guglielmo Poletti.

fr — L'application, la qualité de la production, la culture industrielle et conceptuelle comme valeurs fondatrices de l'entreprise : telle est l'identité de Desalto, ce fil conducteur rigoureux qui a toujours accompagné chaque produit de la collection. Un catalogue qui s'enrichit avec minutie, grâce à une sélection raisonnée de meubles dessinés par des designers de valeur : des produits raffinés et polyvalents, réalisés avec un grand savoir-

faire, des détails soignés et inattendus. Trois nouveaux produits, entre défi conceptuel, rigueur esthétique et innovation technologique : une table à rallonges en équilibre parfait entre forme et fonction, de Gordon Guillaumier ; un meuble modulaire de rangement avec un effet matière marqué, de Giacomo Moor ; une famille de tables et tables basses dont le signe distinctif est la géométrie de la construction, de Guglielmo Poletti.

es — Esmero, calidad de producción, cultura industrial y de diseño como valores corporativos fundamentales: esta es la identidad de Desalto, ese riguroso hilo conductor que siempre ha acompañado a todos los productos de la colección. Un catálogo que se enriquece con atención, gracias a una selección razonada de muebles ideados por diseñadores de alto nivel: productos refinados y versátiles, contruidos con habilidad y maestría, con detalles minuciosos e inesperados. Tres nuevos productos, entre reto de diseño, rigor estético y actualización tecnológica: una mesa extensible en perfecto equilibrio entre forma y función, de Gordon Guillaumier; un mueble contenedor modular con efecto de fuerte materialidad, de Giacomo Moor; una familia de mesas y mesas de centro que encuentra su marca distintiva en la geometría de la construcción, de Guglielmo Poletti.

Un raffinato tavolo da pranzo si fa protagonista nell'ambiente: un progetto di grande rigore che parla il linguaggio della leggerezza.

A refined dining table becomes protagonist in the room: an extremely rigorous design that speaks the language of lightness.

refinement

Fourmore — tavolo / table
design Gordon Guillaumier
2020



Fourmore — tavolo / table
design Gordon Guillaumier
2020

Lisbona — sedia / chair
Pocci + Dondoli
2009





Lisbona — sedia
rivestimento: pelle Nuvola
M81 Antracite

Lisbona — chair
covering: leather Nuvola
M81 Antracite



Fourmore – tavolo
struttura: B42 grafite
/ top: C76 rovere grafite

Fourmore – table
frame: B42 grafite
/ top: C76 grafite oak



Fourmore – tavolo / table
design Gordon Guillaumier
2020

Ply – sedia / chair
design Pocci + Dondoli
2017





Ply — sedia
struttura: B62 bianco opaco
/ rivestimento: H50 cuoio bianco

Ply — chair
frame: B62 matt white
/ covering: H50 white cowhide



Fourmore — tavolo
struttura: B62 bianco opaco
/ top: C88 rovere naturale

Fourmore — table
frame: B62 matt white
/ top: C88 natural oak

L45 — tavolo / table
design Guglielmo Poletti
2020

Koki — sedia / chair
design Pocci + Dondoli
2015

Stac — madia / cabinet
design Giacomo Moor
2020



Quando il dettaglio tecnico è al contempo dettaglio estetico: una famiglia di tavoli e tavolini dall'inatteso e calibrato equilibrio tra piano e struttura.

When technical detail is also aesthetic detail: a family of tables and small tables with an unexpected and calibrated balance between top and structure.

L45 – tavolo / table
design Guglielmo Poletti
2020

Koki – sedia / chair
design Pocci + Dondoli
2015

rigour



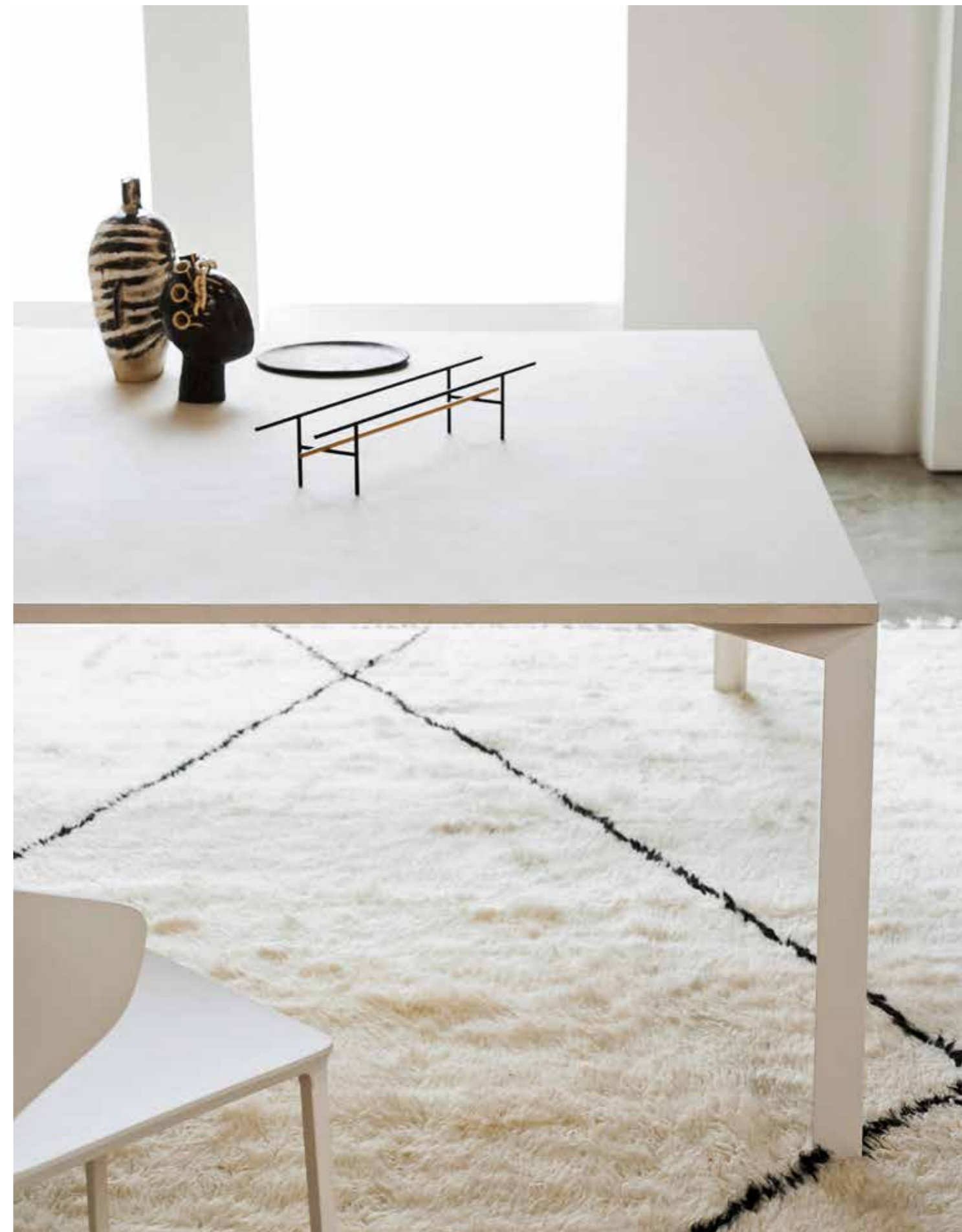

L45 – tavolo
struttura: B62 bianco opaco
/ top: D61 cemento bianco

L45 – table
frame: B62 matt white
/ top: D61 cemento bianco

Volumi sovrapposti,
leggeri: una famiglia
di contenitori con attenti
dettagli progettuali
valorizzati dal legno
e dal metallo.

Overlapped light volumes:
a storage units family
with careful design details
enhanced by wood
and metal.

Stac – madia
contenitore: C95 noce canaletto
/ basamento: B42 grafite opaco

Stac – cabinet
storage unit: C95 canaletto walnut
/ base: B42 matt grafite

sign

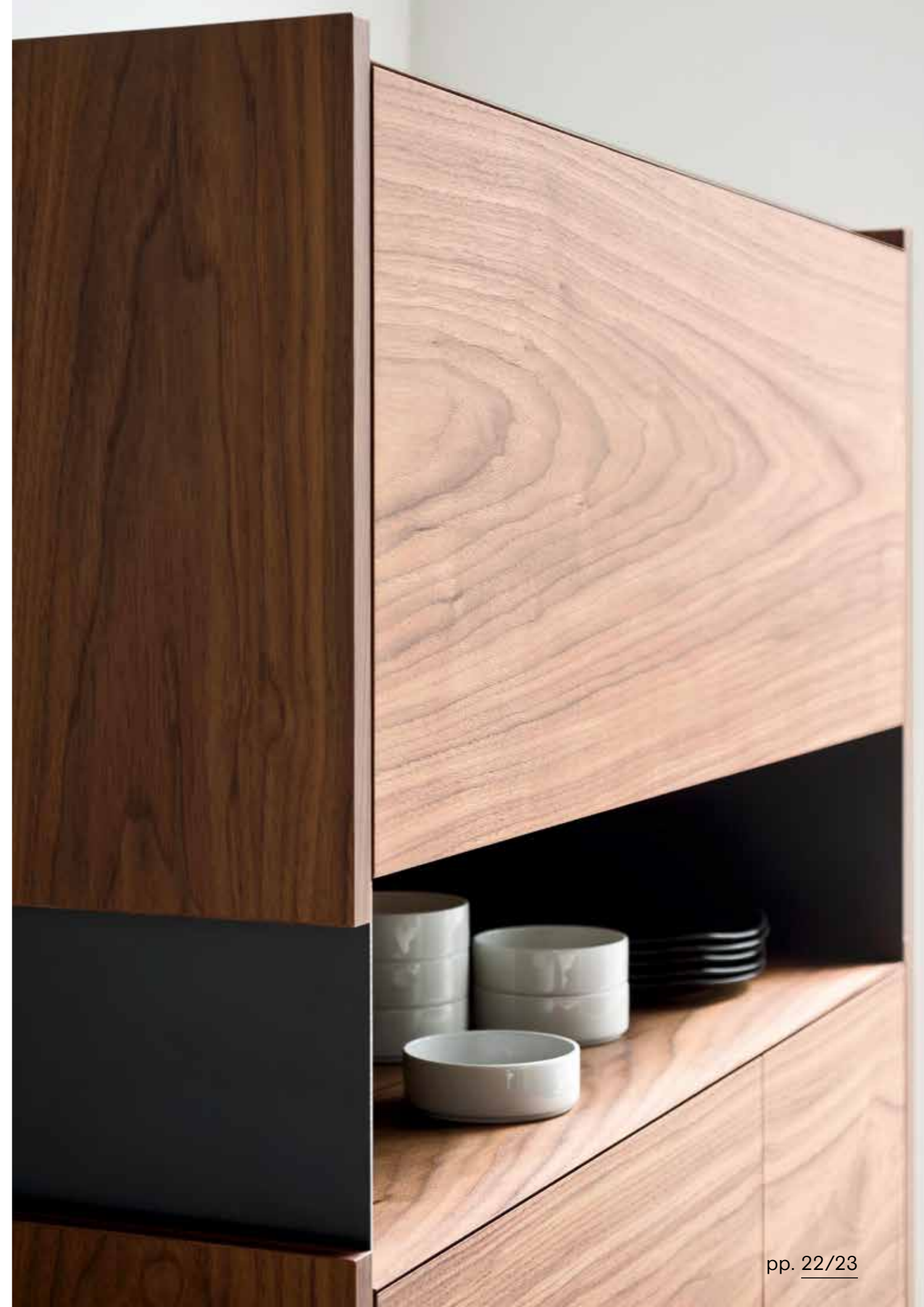



Stac – madia
contenitore: C95 noce canaletto
/ basamento: B42 grafite opaco



Stac – cabinet
storage unit: C95 canaletto walnut
/ base: B42 matt grafite





L45 — tavolino / small table
design Guglielmo Poletti
2020

struttura: A21 ossidiana spazzolato
/ top: D66 cemento nero

frame: A21 brushed ossidiana
/ top: D66 cemento nero

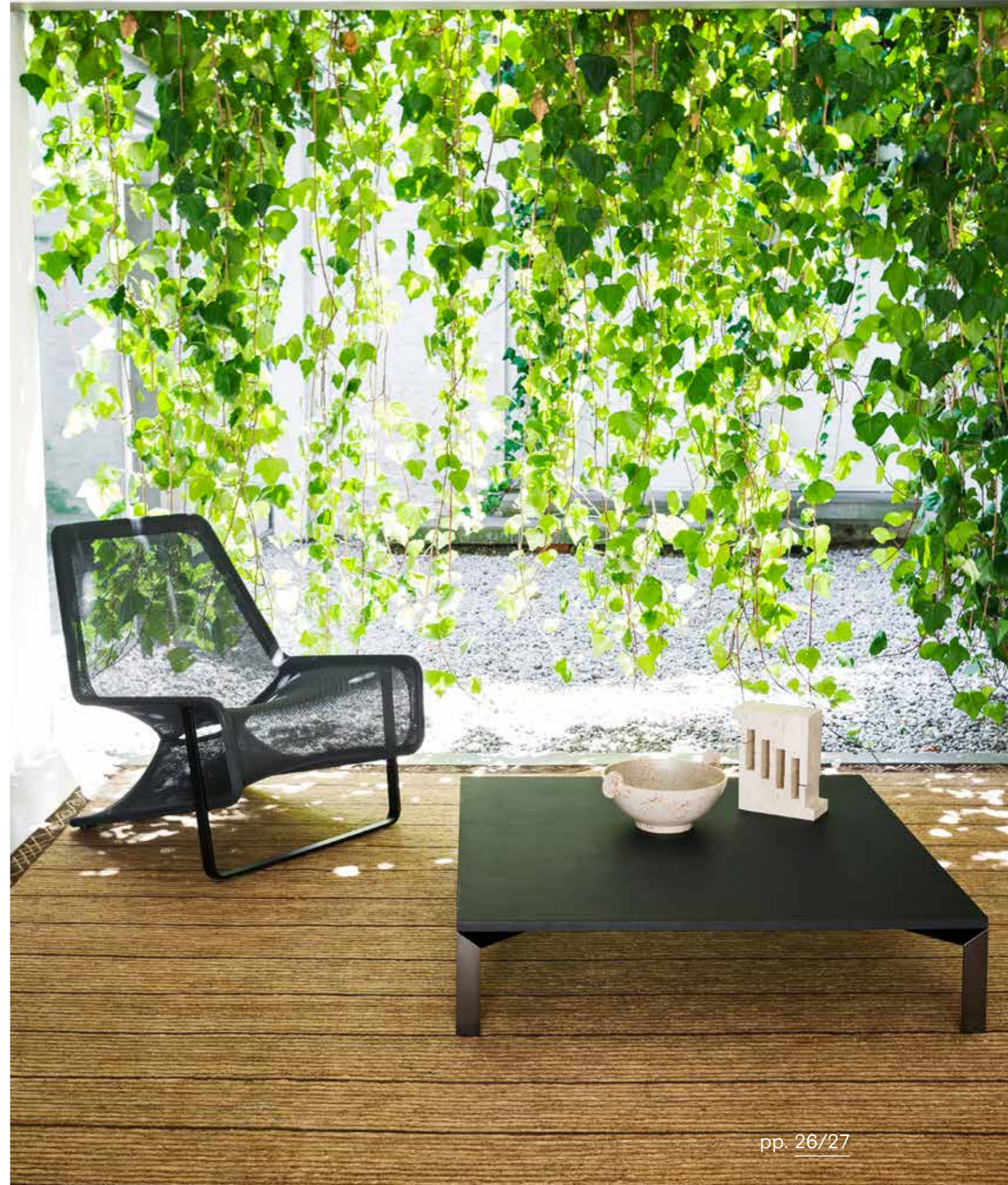

Aria / lounge chair
design Atelier Oi
2019

struttura: B59 nero opaco
/ rivestimento: S10 cenere

frame: B59 matt black
/ covering: S10 cenere



L45 — tavolo / table
design Guglielmo Poletti
2020

Nara — sedia / chair
design Piergiorgio Cazzaniga
2014

Stac — madia / cabinet
design Giacomo Moor
2020



geometry



Nara – sedia
struttura: A18 ossidiana opaco
/ rivestimento: Messenger
T94 Ottanio

Nara – chair
frame: A18 matt ossidiana
/ covering: Messenger
T94 Ottanio

L45 – tavolo
struttura: A21 ossidiana spazzolato
/ top: C76 rovere grafite

L45 – table
frame: A21 brushed ossidiana
/ top: C76 grafite oak

Elementi monolitici
in armonia, dal disegno
pulito e preciso:
un mobile contenitore
come presenza
di carattere a connotare
lo spazio domestico.

Monolithic elements
in harmony, with clean,
precise design:
a storage unit as
presence of character,
adding significance
to the domestic space.

Stac – madia
contenitore: C76 rovere grafite
/ basamento: B42 grafite opaco

Stac – cabinet
storage unit: C76 grafite oak
/ base: B42 matt grafite





Stac – madia
contenitore: C76 rovere grafite
/ basamento: B42 grafite opaco

Stac – cabinet
storage unit: C76 grafite oak
/ base: B42 matt grafite



Strong — sedia / chair
design Eugenie Quitlet
2019

Clay+Lazy Susan — tavolo / table
design Marc Krusin
2015



Clay+Lazy Susan – tavolo / table
base+top: D66 cemento nero



Strong – sedia
struttura: A27 titanium
/ rivestimento: Messenger
T95 Prussia

Strong – chair
frame: A27 titanium
/ covering: Messenger
T95 Prussia



Stac — cabinet
Fourmore — table
L45 — table, small table

Aria — lounge chair, pouf

Koki — chair
Lisbona — chair
Nara — chair
Ply — chair
Strong — chair

Clay — table



abaco

Stac — cabinet

design Giacomo Moor



Stac — cabinet

design Giacomo Moor

Finiture / Finishes

Sistema di contenitori in legno con struttura in lamiera di metallo.

Wooden containers system with metal sheet structure.

System von Holzcontainern mit basis aus stahlblech.

Système d'éléments de rangement en bois avec base en acier.

Sistema de contenedores en madera con base en acero.

Storage unit

Essenze / Woods

C14 rovere laccato nero / black lacquered oak
C68 rovere moro / moro oak
C78 rovere grafite / grafite oak
C88 rovere naturale / natural oak
C95 noce canaletto / canaletto walnut

Basamento e vano giorno

/ Base and open compartment

Laccati / Lacquers

B13 sabbia
B42 grafite
B59 nero opaco / matt black
B62 bianco opaco / matt white

Metalli / Metals

A74 ferro naturale / natural iron

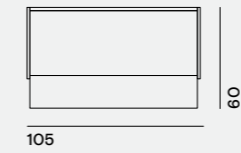

Stac — 343 B
misure / dimensions:
cm 105x45

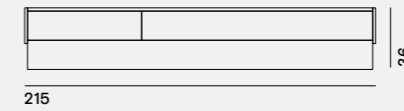

Stac — 343 D
misure / dimensions:
cm 215x45

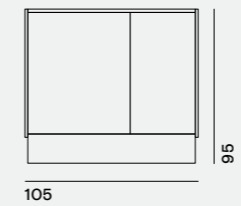

Stac — 343 A
misure / dimensions:
cm 105x45

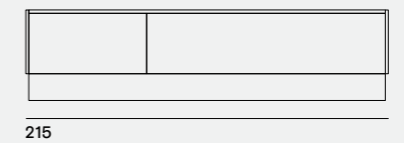

Stac — 343 C
misure / dimensions:
cm 215x45

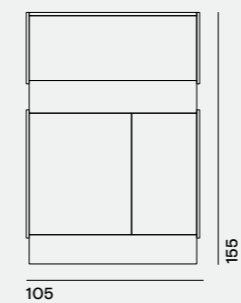

Stac — 343 E
misure / dimensions:
cm 105x45

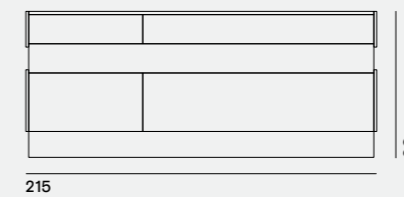

Stac — 343 F
misure / dimensions:
cm 215x45





Fourmore — table

design Gordon Guillaumier

Finiture / Finishes

Tavolo con struttura del telaio realizzata in lamiera di acciaio da 10 mm tagliata laser; top e prolunga fresati a controllo numerico (25 mm). Dettagli meccanici in plastica stampata su disegno specifico. Sistemi di scorrimento su guide di alluminio con pattini autolubrificanti.

Table avec structure en acier 10 mm, coupée au laser, plateau et rallonge fraisés par machine à contrôle numérique (25 mm). Détails mécaniques en plastique moulée selon design spécifique. Systèmes de glissement sur guides en aluminium avec patins auto-lubrifiants.

Table with frame structure made of 10 mm laser cut steel sheet, CNC-milled top and extension (25 mm). Mechanical details in moulded plastic on specific design. Sliding systems on aluminium tracks with self-lubricating runners.

Mesa con estructura en acero de 10 mm, cortada a laser. La encimera y sobre extensible están fresados con máquina de control numérico (25 mm). Detalles mecánicos en plástico moldeado sobre diseño técnico. Sistema deslizante con guías en aluminio con patines autolubricantes.

Tisch mit gestell aus stahlblech 10 mm, mit laser geschnitten, platte und ausziehplatte mit steuerungsprogramm gefräst (25 mm). Mechanische komponenten aus formgepresstem kunststoff. Selbstschmierende fuehrungsschienen aus aluminium.

Struttura / Frame

Laccati / Lacquers

B13 sabbia
B42 grafite
B59 nero opaco / matt black
B62 bianco opaco / matt white

Top

Essenze / Woods

C14 rovere laccato nero / black lacquered oak
C68 rovere moro / moro oak
C78 rovere grafite / grafite oak
C88 rovere naturale / natural oak
C95 noce canaletto / canaletto walnut

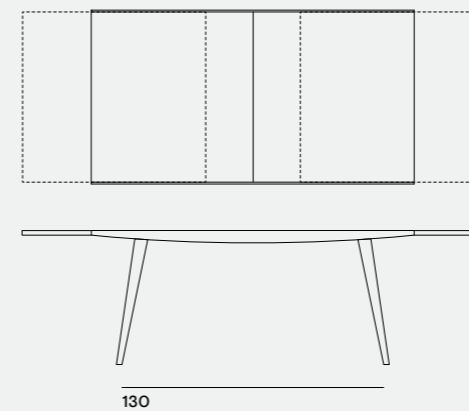

Fourmore
misure / dimensions:
cm 90×180 (250)

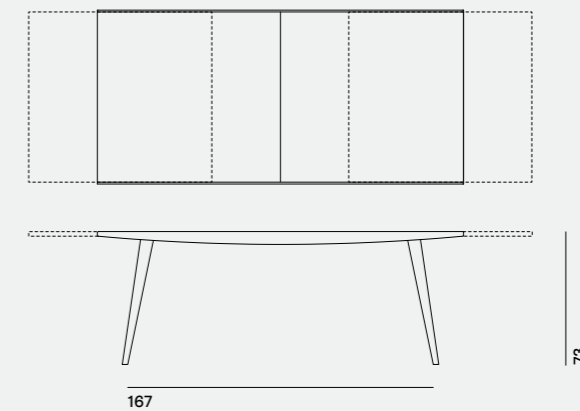

Fourmore
misure / dimensions:
cm 95×200 (275)





L45 – table

design Guglielmo Poletti

Gambe in angolare di acciaio con spessore di 6 mm lavorate a controllo numerico; telaio in angolare di acciaio con spessore di 5 mm lavorato a controllo numerico. Top in legno, laminato Fenix o spatolato cemento.

Tables and small tables collection with angular steel legs, 6 mm thickness, CNC-machined. Frame in angular steel with 5 mm thickness, CNC-machined. Honeycomb top with solid wood, fenix or hand-spread concrete finishes.

Eckige stahlbeine, materialstaerke 6 mm, mit steuerungsprogramm bearbeitet, rahmen aus stahlwinkeln materialstaerke 5 mm, ebenfalls mit steuerungsprogramm bearbeitet. Platte aus holz furniert.

Pieds angulaires en acier, 6 mm travaillé avec machine à contrôle numérique, cadre angulaire en acier 5 mm d'épaisseur travaillé avec machine à contrôle numérique. Plateau en bois, en fenix ou recouvert de ciment étalé à la main.

Patas angulares en acero de 6 mm, moldeadas con máquina de control numérico, estructura también en acero con espesor 5 m, y moldeada con máquina de control numérico. Top en madera, en laminado fenix o en cemento aplicado a mano con espátula.

Finiture / Finishes

Struttura / Frame

Laccati / Lacquers

B13 sabbia
B42 grafite
B59 nero opaco / matt black
B62 bianco opaco / matt white
B70 rosso lampone / lampone red

Metalli / Metals

A21 ossidiana spazzolato / brushed ossidiana
A27 titanium

Top

Essenze / Woods

C14 rovere laccato nero / black lacquered oak
C68 rovere moro / moro oak
C78 rovere grafite / grafite oak
C88 rovere naturale / natural oak
C95 noce canaletto / canaletto walnut

Fenix

D40 Fenix bianco / white Fenix
D41 Fenix nero / black Fenix
D42 Fenix grigio / grey Fenix
D43 Fenix bordeaux / bordeaux Fenix
D44 Fenix blu notte / blue notte Fenix

Spatolati / Handcraft finishes

D61 cemento bianco
D65 cemento grigio luna
D66 cemento nero

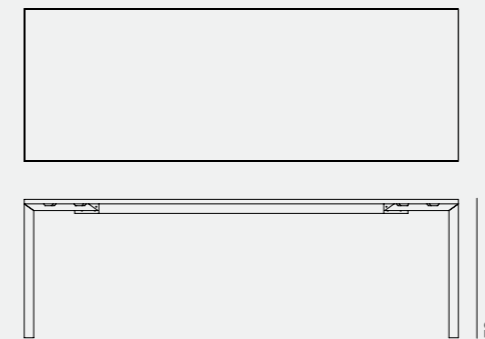

L45

misure / dimensions:

cm 140×85
cm 180×90
cm 200×90
cm 240×90
cm 300×100
cm 180×180



L45 – small table

design Guglielmo Poletti

Finiture / Finishes

Gambe in angolare di acciaio con spessore di 6 mm lavorate a controllo numerico; telaio in angolare di acciaio con spessore di 5 mm lavorato a controllo numerico. Top in legno, laminato Fenix o spatolato cemento.

Pieds angulaires en acier, 6 mm travaillé avec machine à contrôle numérique, cadre angulaire en acier 5 mm d'épaisseur travaillé avec machine à contrôle numérique. Plateau en bois, en fenix ou recouvert de ciment étalé à la main.

Tables and small tables collection with angular steel legs, 6 mm thickness, CNC-machined. Frame in angular steel with 5 mm thickness, CNC-machined. Honeycomb top with solid wood, fenix or hand-spread concrete finishes.

Patas angulares en acero de 6 mm, moldeadas con máquina de control numérico, estructura también en acero con espesor 5 m, y moldeada con máquina de control numérico. Top en madera, en laminado fenix o en cemento aplicado a mano con espátula.

Eckige stahlbeine, materialstärke 6 mm, mit steuerungsprogramm bearbeitet, rahmen aus stahlwinkeln materialstärke 5 mm, ebenfalls mit steuerungsprogramm bearbeitet. Platte aus holz furniert.

Struttura / Frame

Laccati / Lacquers

B13 sabbia
B42 grafite
B59 nero opaco / matt black
B62 bianco opaco / matt white

Metalli / Metals

A21 ossidiana spazzolato / brushed ossidiana
A27 titanium

Top

Essenze / Woods

C14 rovere laccato nero / black lacquered oak
C68 rovere moro / moro oak
C78 rovere grafite / grafite oak
C88 rovere naturale / natural oak
C95 noce canaletto / canaletto walnut

Fenix

D40 Fenix bianco / white Fenix
D41 Fenix nero / black Fenix
D42 Fenix grigio / grey Fenix
D43 Fenix bordeaux / bordeaux Fenix
D44 Fenix blu notte / blue notte Fenix

Spatolati / Handcraft finishes

D61 cemento bianco
D65 cemento grigio luna
D66 cemento nero

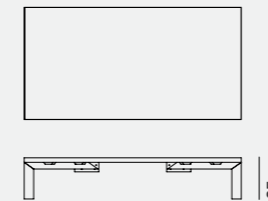

L45
misure / dimensions:
cm 130x65
cm 110x110



Lounge chair con struttura in tubolare di acciaio e seduta in rete elastica. Supporto anteriore in piatto di acciaio laccato.

Chaise longue avec structure en tubulaire d'acier et assise en maille élastique. Support antérieur en assiette d'acier laqué.

Lounge chair with tubular steel frame and seat in elastic net. Front support in lacquered steel plate.

Silla lounge con estructura en tubo de acero y asiento en red elástica. Soporte anterior en placa de acero lacado.

Lounge chair mit Gestell aus Stahlrohr und Sitz aus elastischem Netz. Vordere Halterung aus lackierter Stahlplatte.

Struttura / Frame

Laccati / Lacquers

- B59 nero opaco / matt black
- B62 bianco opaco / matt white
- B70 rosso lampone / lampone red
- B13 sabbia

Rivestimento / Covering

Reti elastiche / Elastic meshes

- S10 cenere
- S11 notte
- S12 beige
- S13 salvia
- S14 corallo

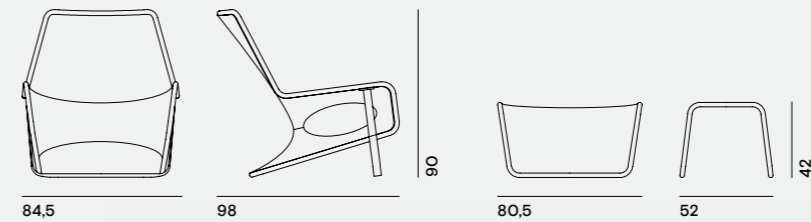

Aria – 565 lounge chair

Aria – 566 pouf



Sedia impilabile con scocca autoportante in poliuretano integrale contenente una struttura in acciaio. Verniciatura realizzata in stampo nelle tonalità goffrate a campionario. Gambe di acciaio in tubolare conificato a sezione quadra laccate negli stessi colori della scocca. Utilizzabile anche per outdoor.

Stacking chair with self-standing body in integral polyurethane, containing a steel frame. Mould-coating available in the different embossed colours as per sample collection. Steel legs in tubular conic shape, square section, lacquered in the same colours as the frame. Also suitable for outdoor.

Stapelbarer Stuhl aus integrealem Polyurethan und Stahlgestell, hergestellt in den Farben der Musterliste. Beine aus konischem Rohr mit quadratischem Abschnitt, lackiert in der gleichen gaufrierten Farbe der Sitzschale. Auch für Outdoor geeignet.

Chaise empilable avec coque autoportante en mousse de polyuréthane intégrale et structure intérieure en acier. Laquage au moulage dans les couleurs gaufrées en collection. Pieds tubulaire en acier à section carrée conique dans les mêmes couleurs que la coque. Utilisable aussi à l'extérieur.

Silla apilable con casco en poliuretano integral barnizado en molde, con estructura interna en acero. Disponible en los colores gofrados de la colección. Patas en acero cónico con sección cuadrada lacadas en los mismos colores que el casco. Apta para uso en el exterior.

Scocche / Seats

Polipropilene / Polypropylene

F18 bianco / white
F36 verde gauguin / gauguin green
F39 nero / black
F46 petrolio
F70 spago
F71 ruggine
F73 marrone bungee / bungee brown
F75 rosso lampone / lampone red
F77 grafite
F78 verde moss / moss green

Struttura / Frame

Laccati / Lacquers

Stessi colori della scocca / Same colors as the seat

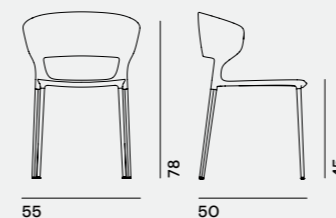

Koki — 707

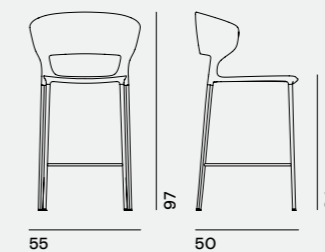

Koki — 708

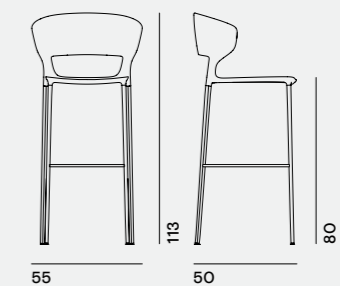

Koki — 708

Sedia non impilabile, con rivestimento cucito a mano in cuoio, cuoietto, pelle ed ecopelle; struttura in polipropilene caricato con fibra di vetro. Disponibile nelle varianti del campionario.

Not stackable chair, with hand-sewed covering in cow hide, cuoietto, leather and ecoleather, and structure of polypropylene reinforced with fibre glass. Available in all the colours of our collection.

Stuhl mit Bezug aus handgenähtem Kernleder, Cuoietto, Leder und Kunstleder, Gestell aus glasfaserverstärktem Polypropylen. Verfügbar in den Farben der Kollektion. Nicht stapelbar.

Chaise non empilable, avec revêtement cousu à la main en cuir sellier, cuoietto, cuir souple et simili-cuir, avec structure en polypropylène chargé de fibre de verre. Disponible dans les couleurs de notre collection.

Silla no apilable, con funda en cuero, cuoietto, piel y piel ecológica, cosido a mano, con estructura en polipropileno cargado con fibra de vidrio. Disponible en las variantes del muestrario.

Scocche / Seats

Rivestimenti / Coverings

Pelle
Pelle Nuvola
Ecopelle
Ecopelle Grain
Ecopelle Glove
Cuoio / Cowhide
Cuoietto

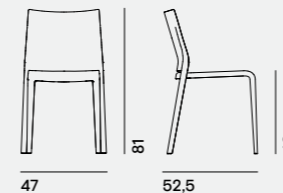

Lisbona — 544



Nara — chair

design Piergiorgio Cazzaniga

Finiture / Finishes

Sedia imbottita in tessuto sfoderabile, pelle o ecopelle. Scocca in poliuretano flessibile con cinghie elastiche inserite nella seduta. Gambe in pressofusione di alluminio.

Upholstered chair with removable fabric, leather or eco-leather. Seat and back in flexible polyurethane with seat elastic belt. Die-cast aluminium legs.

Gepolsterter Stuhl aus Stoff (abnehmbar), Leder oder Kunstleder. Sitzschale aus Polyurethan mit elastischer Gurtung. Beine aus Aluminiumdruckguss.

Chaise rembourrée en tissu déhoussable, cuir souple ou simili cuir. Coque en polyuréthane flexible avec sangles élastiques insérées dans l'assise. Pieds moulés sous pression.

Silla acolchada en tejido desenfundable, piel o piel ecológica. Casco e poliuretano flexible con cinchas elásticas introducidas en el asiento. Patas en fusión de aluminio.

Struttura / Frame

Laccati / Lacquers

B42 grafite
B59 nero opaco / matt black
B84 grigio umbro / umbro grey

Metalli / Metals

A18 ossidiana opaco / matt ossidiana

Sedile / Seat

Rivestimento / Coverings

Dandy (cat. A)
Loden (cat. A)
Softy (cat. B)
Kvadrat Messenger (cat. C)
Pelle
Pelle Nuvola
Ecopelle
Ecopelle Grain
Ecopelle Glove

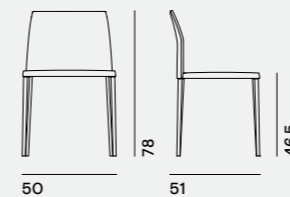

Nara — 696

Sedia impilabile con struttura in acciaio. Sedile e schienale in polipropilene caricato con fibra di vetro, disponibili anche rivestiti in cuoio e cuoietto. Il polipropilene è stabilizzato anti UV. Gambe in acciaio conificato a sezione triangolare. Disponibile anche nella versione sgabello, con e senza braccioli.

Stackable chair with steel frame. Seat and back in polypropylene reinforced with glass fibre, available also covered with cow-hide and cuoietto. The polypropylene is stabilised anti-UV. Steel legs in conic shape, with triangular section. Also available as a stool with and without armrests.

Stapelbarer Stuhl mit Stahlgestell. Sitz und Rückenlehne aus Glasfaserverstärktem Polypropylen, verfügbar auch bezogen mit Kernleder und Cuoietto. Das Polypropylen ist UV-Strahlen geschützt. Beine aus konischem Stahl mit dreieckigem Abschnitt.

Chaise empilable avec structure en acier. Assise et dossier en polypropylène chargé de fibre de verre, disponibles aussi revêtus en cuir sellier et cuoietto. Le polypropylène est stabilisé anti-UV. Pieds en acier conique à section triangulaire. Disponible aussi en version tabouret avec ou sans accoudoirs.

Silla apilable con estructura de acero. Asiento y respaldo en polipropileno cargado con fibra de vidrio, también disponible tapizados en cuero y cuoietto. El polipropileno está estabilizado anti-UV. Patas de acero cónico con sección triangular. También disponible la versión de taburete con y sin brazos.

Struttura / Frame

- Laccati / Lacquers**
 B22 marrone bungee / bungee brown
 B41 tortora
 B42 grafite
 B59 nero opaco / matt black
 B62 bianco opaco / matt white
 B70 rosso lampone / lampone red
 B72 blu denim / denim blue
 B81 curry
 B84 grigio umbro / umbro grey

Sedile / Seat

- Polipropilene / Polypropylene**
 F73 marrone bungee / bungee brown
 F38 tortora
 F77 grafite
 F39 nero opaco / matt black
 F18 bianco opaco / matt white
 F75 rosso lampone / lampone red
 F74 blu denim / denim blue
 F37 curry

- Rivestimenti / Coverings**
 Cuoio / Cowhide
 Cuoietto

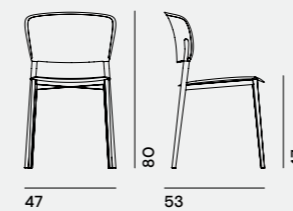

Ply - 718

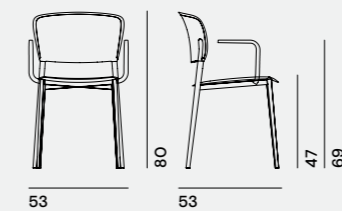

Ply - 717

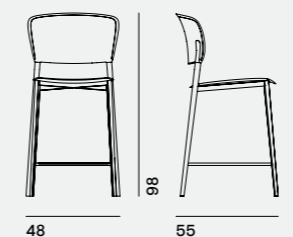

Ply - 729

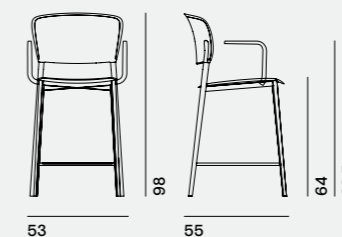

Ply - 728



Strong – chair

design Eugeni Quitllet

Finiture / Finishes

Sedia con struttura in tubolare di acciaio curvato ø 35 mm. Seduta imbottita e rivestita in tessuto, pelle o ecopelle.

Chaise avec structure en tubulaire d'acier courbée ø 35 mm. Assise rembourrée et revêtue en tissu, cuir ou simili cuir.

Chair with frame in folded tubular steel ø 35 mm. Upholstered chair covered with fabric, leather or ecoleather.

Silla con estructura en tubo de acero curvado ø 35 mm. Asiento alcohado y revestido en tejido, piel o piel ecológica.

Stuhl mit Gestell aus gebogenem Stahlrohr ø 35 mm. Polstersitz bezogen aus Stoff, Leder oder Artleder.

Struttura / Frame

Laccati / Lacquers

B13 sabbia
B22 marrone bungee / bungee brown
B42 grafite
B59 nero opaco / matt black
B62 bianco opaco / matt white
B82 grigio / grey
B84 grigio umbro / umbro grey
B70 rosso lampone / lampone red

Metalli / Metals

A21 ossidiana spazzolato / brushed ossidiana
A27 titanium

Sedile / Seat

Rivestimenti / Coverings

Messenger (Cat. C)
Softy (Cat. B)
Dandy (Cat. A)
Loden (Cat. A)
Ecopelle
Ecopelle Grain
Ecopelle Glove
Pelle / Leather
Pelle Nuvola / Ecoleather

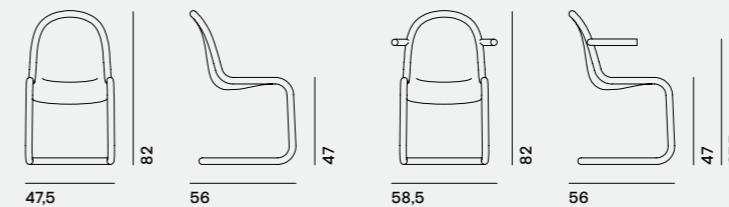

Strong – 732

Strong – 734



Tavolo con vassoio girevole incorporato dotato di meccanismo di rotazione su cuscinetti a sfera. Basamento in poliuretano rigido e piano in MDF. Vassoio girevole nella stessa finitura del tavolo.

Table with built-in rotating tray with rotating mechanism on ball bearings. Base in rigid polyurethane and MDF top. Rotating tray in the same finish as the table.

Tisch mit integriertem drehbarem Tablett mit Rotationsmechanismus auf Kugellager. Basis aus hartem Polyurethan und MDF Platte. Drehbares Lazy Susan in der gleichen Ausführung des Tisches.

Table avec plateau central pivotant intégré en affleurement équipé d'un mécanisme de rotation sur roulement à billes. Base en polyuréthane rigide et plateau en MDF. Plateau pivotant dans la même finition que la table.

Mesa con bandeja central giratoria incorporada en rasado al top equipada con mecanismo de rotación sobre rodamientos con bolas. Base en poliuretano rígido y encimera en MDF. Bandeja giratoria en el mismo acabado que la mesa.

Base+Top**Metal**

A90 metal grey
A92 metal bronze

Stone

D61 cemento bianco
D65 cemento grigio luna
D66 cemento nero

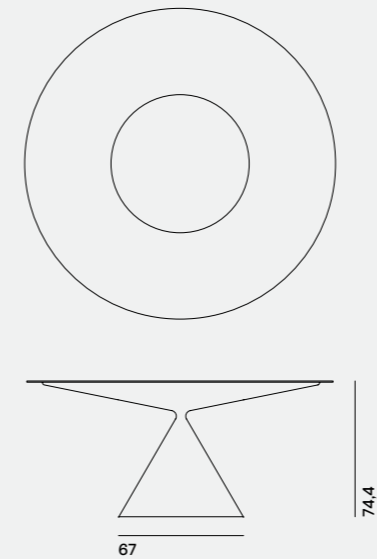

Clay+Lazy Susan — 701

misure / dimensions:

Ø cm 160 — Lazy Susan Ø cm 60

Ø cm 180 — Lazy Susan Ø cm 80

Ø cm 200 — Lazy Susan Ø cm 100



Atelier Oï

pp. 27, **56/57**
– Aria / lounge chair+pouf

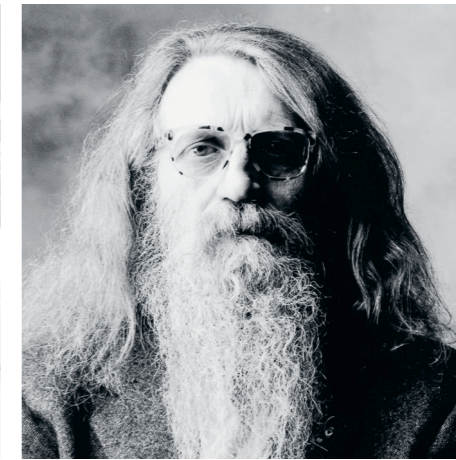

Piergiorgio Cazzaniga

pp. 28/29, 30, 31, **62/63**
– Nara / chair



Gordon Guillaumier

pp. 05, 06/07, 08, 09, 10, 11, 12/13,
15, **46/49** – Fourmore / table



Marc Krusin

pp. 36/37, 38, 39, **68/69**
– Clay+Lazy / table

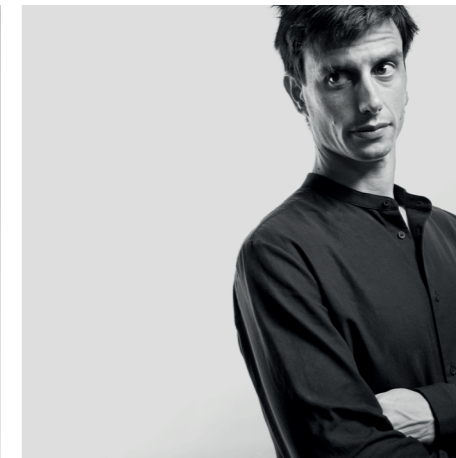

Giacomo Moor

pp. 16/17, 23, 24, 25, 28/29, 33, 34,
35, **42/45** – Stac / cabinet



Poggi + Dondoli

pp. 16/17, 19, **58/59** – Koki / chair
pp. 06/07, 08, 09, **60/61**
– Lisbona / chair
pp. 12/13, 14, **64/65** – Ply / chair



Guglielmo Poletti

pp. 16/17, 19, 20, 21, 28/29, 30, 31,
50/53 – L45 / table
pp. 26, 27, **54/55** – L45 / small
table



Eugeni Quitllet

pp. 36/37, 38, 39, **66/67**
– Strong / chair

Update 2

art direction
Studio Gordon Guillaumier
graphic design
Designwork

photographs
Andrea Ferrari
styling
Maria Gabriella Zecca
still photographs
Cesare Chimenti

texts
Elisa Testori

colour separation
Luce
printed in Italy by
Grafica Gioia

08.2020 ©Desalto Spa

thanks to:
Amini carpets
Artemide
Danese
Flos
Henzel Studio Rugs
Mani Ceramics
Rotaliana
Sara Scalzotto Studio

special thanks to the artists:
Nataly Maier
courtesy Artesilva
Paolo Iacchetti
courtesy Artesilva
Wolfram Ullrich
courtesy Dep Art Gallery

Desalto Spa
via per Montesolaro
C.P. 150
22063 Cantù – CO
Italy

t +39 031 7832211
f +39 031 7832290
info@desalto.it
desalto.it

