



LOGICA

PARETI DIVISORIE

Partition walls | *Parois de séparation*

LOGICA

LOGICA

Pareti divisorie

Partition walls

Parois de séparation

La nostra Azienda propone, per la divisione dello spazio ufficio, una moderna e funzionale collezione di robuste pareti divisorie e attrezzate, facilmente integrabili a pavimenti, pavimenti flottanti, soffitti, controsoffitti e muri perimetrali.

To divide office open spaces, our Company proposes a modern, functional collection of study partition and equipped panels that can be easily fixed to floors, floating floors, ceilings, false ceilings and perimeter walls.

Notre entreprise propose, pour la division de l'espace de travail, une collection moderne et fonctionnelle de parois de séparation robustes et équipées, facilement intégrables à des sols, sols flottants, plafonds, faux-plafonds et murs périmétraux.

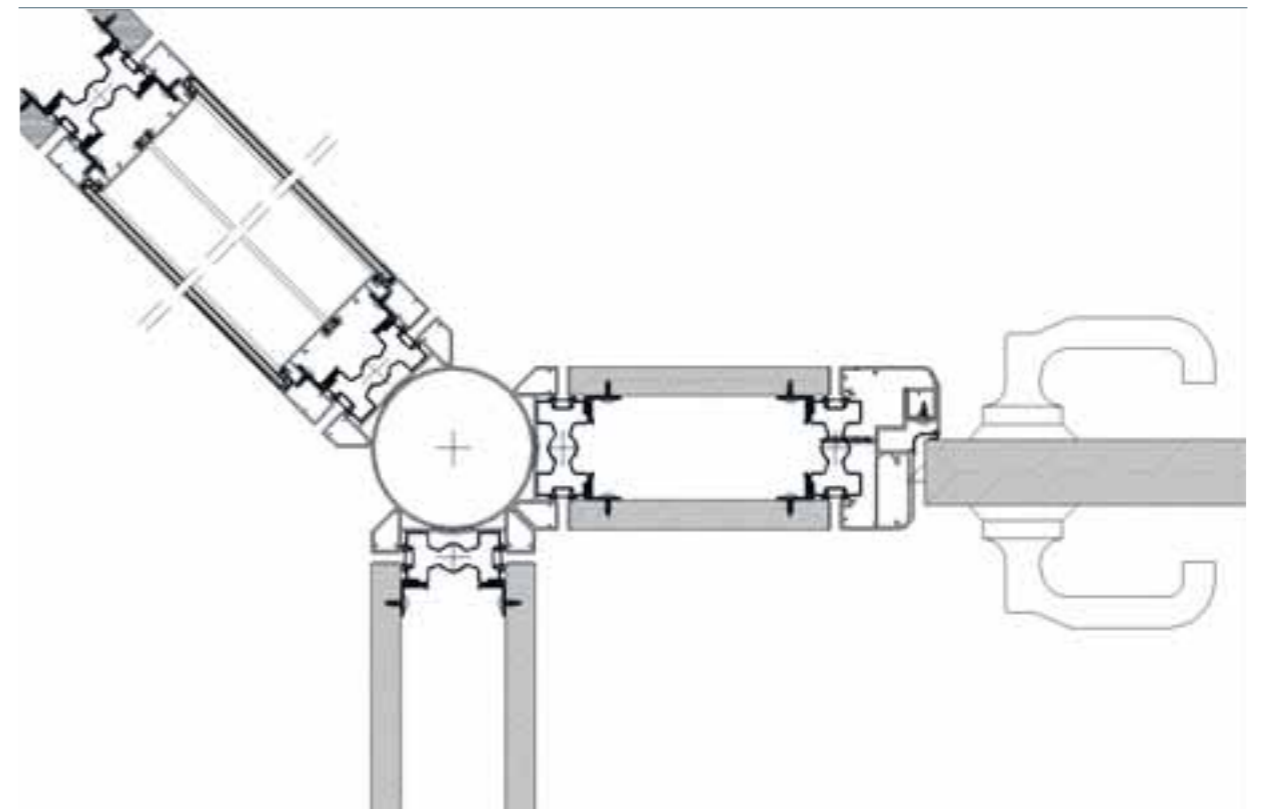
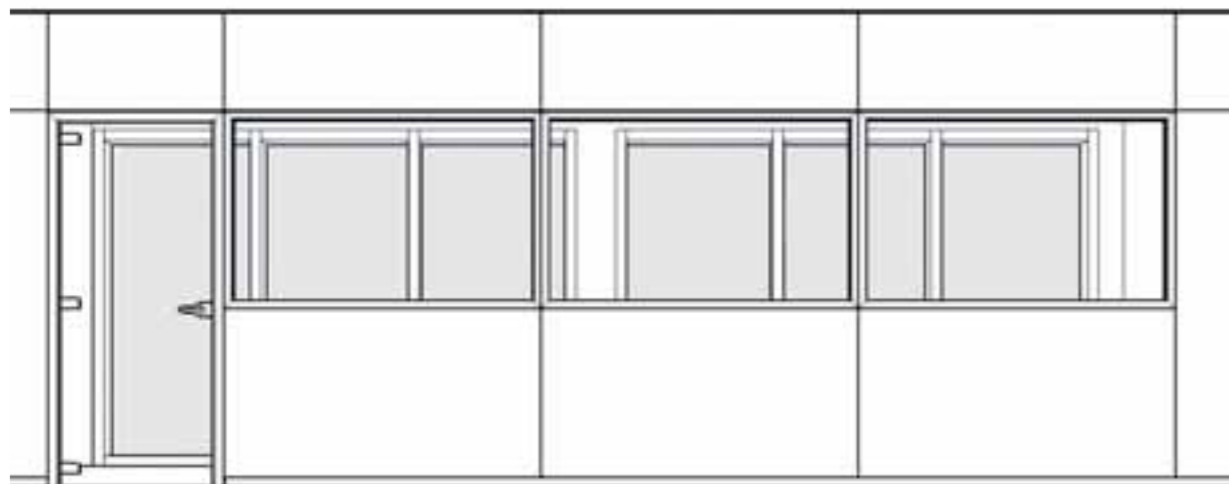











Con gli angoli
variabili in alluminio
è possibile inclinare
le pareti a piacere e
realizzare raccordi a
3 o 4 vie.

With the adjustable
aluminium corners,
the partition walls
can be tilted as
you prefer and you
can also realize
connections at 3 or
4 ways.

Avec des angles
variables aluminium
vous pouvez incliner
les cloison à volonté et
créer des connexions
à 3 ou 4 voies.

Angolo fisso a 90° in laminato.
90° laminate fixed corner.
Angle fixe de 90° en stratifié.





16 Le finestre delle pareti divisorie sono in realtà il risultato di due semi-finestre contrapposte. Nel punto di contatto sono presenti due guarnizioni a palloncino, che garantiscono l'ermeticità del prodotto composito. A richiesta è possibile montare tra le due semi-finestre, delle tende veneziane a lamelle da 25 mm, con comando orientabile manuale

The windows in the partition panel are, actually, the result of two opposed half-windows. The contact point features two balloon gaskets that ensure the tightness of this composite product. Upon demand, we may also assemble Venetian blinds with 25 mm strips between the two half-windows, with manual tilt control.

Les fenêtres des parois de separation sont en réalité le résultat de deux demi-fenêtres opposées. Au point de contact, se trouvent deux garnitures en forme de ballon, qui garantissent l'herméticité du produit composite. Sur demande, il est possible de monter entre les deux demi-fenêtres, des stores vénitiens à lames de 25 mm avec commande orientable manuelle.



La trasparenza oltre ad essere un valore competitiva è anche parte integrante della nostra cultura aziendale. L'ufficio "in chiaro" rappresenta un valore aggiunto all'ambiente di lavoro favorendo infatti la comunicazione, l'armonia e l'operosità fra le persone del collettivo chi vi opera.

Transparency is not only a competitive value, but also an integral element of our company culture. The "see-through" office is an added value for the environment, because it favours communication, harmony and laboriousness among the people working on the same office space.

La transparence, en plus d'être une valeur compétitive, est également partie intégrante de notre culture d'entreprise. Le bureau "en clair" représente une valeur ajoutée à l'ambiance de travail en favorisant en effet la communication, l'harmonie et l'activité entre les personnes du groupe qui y travaille.





Nelle parti cieche c'è lo spazio per posizionare interruttori luce o prese elettriche.

On the blind parts there is the space to put switches.

Dans certaines parties aveugle il ya l'espace pour placer les interrupteurs ou de prises électriques.



Chiusura terminale in centro stanza in alluminio o laminato.



Aluminium or laminate final closing for the middle of the room.

Fermeture terminale au centre de la salle en aluminium ou stratifié.











Telaio in alluminio con doppio vetro, complanare.

Aluminium frame
coplanar, double
glass.

*Châssis en aluminium
avec double vitrage,
coplanaires.*





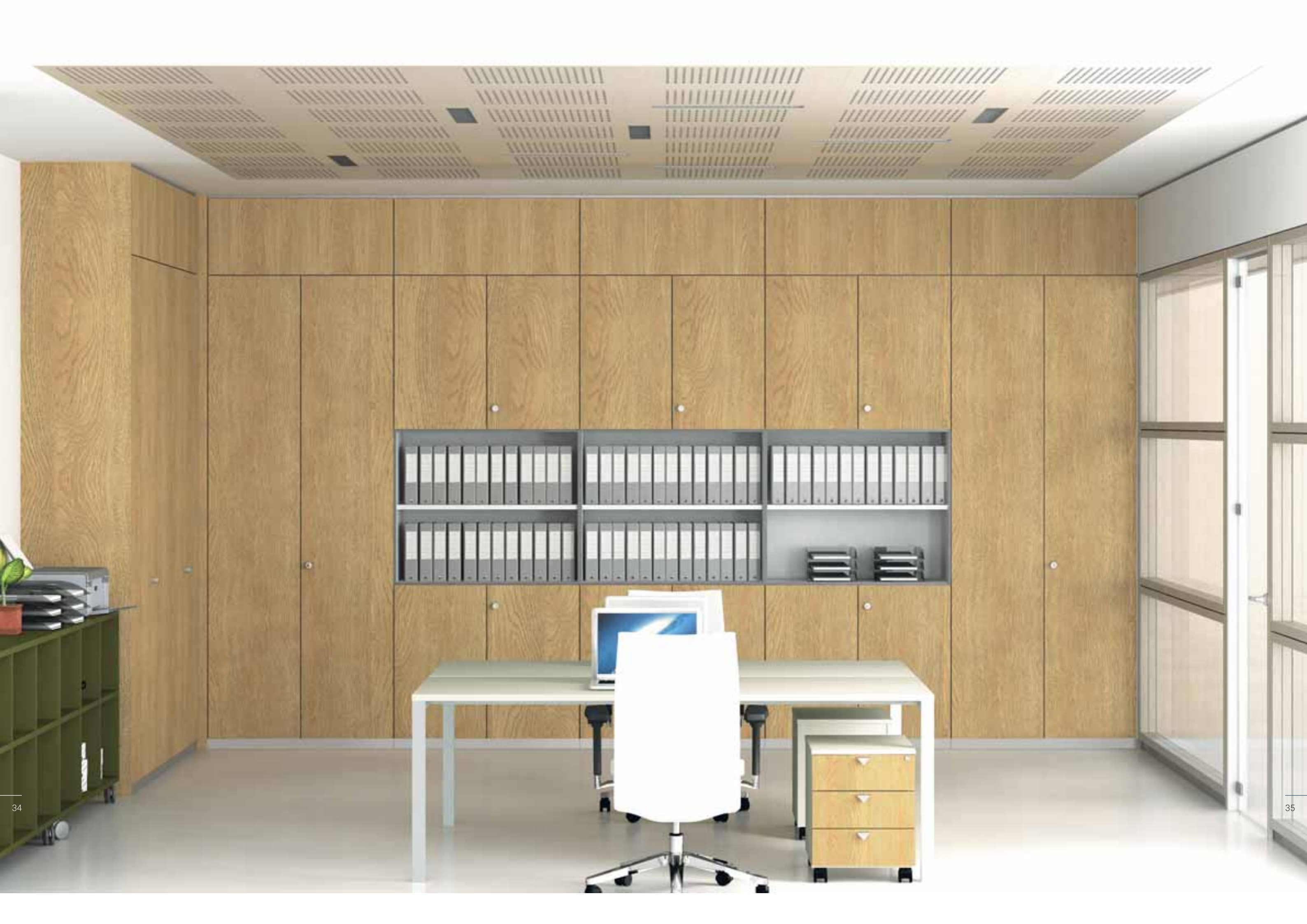

La struttura dell'armadio può essere personalizzata partendo dalla versione base con bordi in ABS in tinta con il fianco, fino ad arrivare a soluzioni più tecniche con bordi con guarnizione grigia o con cremagliere in alluminio forate a passo 32 mm.



The cupboard structure can be personalized: there is the basic version with ABS edges in the same finish of the side, or more technical versions such as the edges with grey protection or aluminium rack where the holes are each 32 mm.



La structure de l'armoire peut être personnalisée à partir de la version base avec des bords en ABS de la même couleur/finition de le côté jusqu'à obtenir des solutions plus technique avec joint d'étanchéité gris ou avec râtelier en aluminium perforé avec trou chaque 32 mm.







Sono disponibili a richiesta ripiani metallici realizzati in lamiera piegata verniciata grigia, predisposti nella parte sottostante per l'aggancio delle cartelle sospese con interasse 330 mm a lettura orizzontale

On request metal shelves are available in bent sheet metal, painted grey. Undemeath they are prepared for holding suspended folders with a 330 mm vertical interaxis. Also on request Ibra cupboards can be furnished with convenient removable folder frames for vertical folders with a 395 mm centre line.

Sur demande, il est également possible d'obtenir des étagères métalliques réalisées en tôle pliée peinte en gris, prévues dans la partie inférieure pour l'accrochage des dossiers suspendus avec un entraxe de 330 mm à lecture verticale. Toujours sur demande; il est possible de garnir les systèmes d'armoire avec des châssis porte-dossiers amovibles très pratiques, pour y ranger des dossiers avec un entraxe de 395 mm à lecture horizontale.

















LOGICA
 FINITURE E COLORI
 FINISHES AND COLOURS
 FINITIONS ET COLORIS

MELAMINICO
 MELAMINE - MÉLAMINE

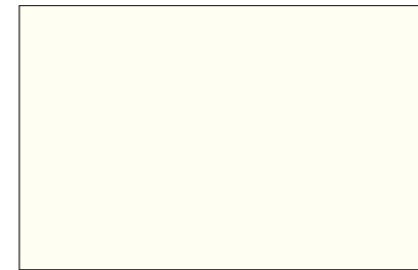

M001 - Bianco

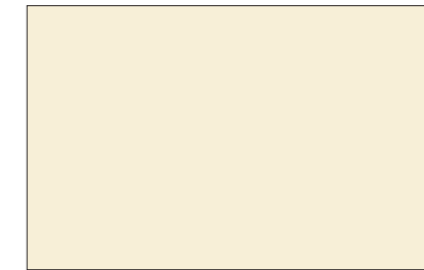

M011 - Corda

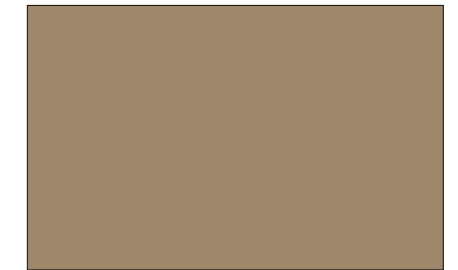

M785 - Marrone



M700 - Grigio

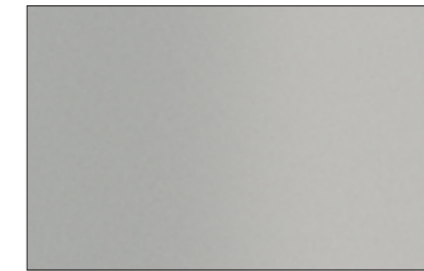

M750 - Irony

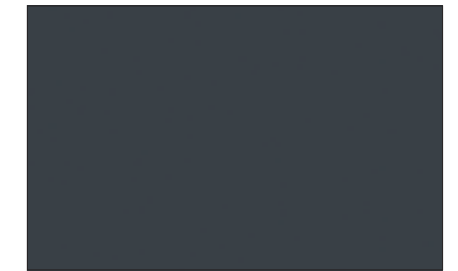

M782 - Antracite



M941 - Frassino Bianco



M900 - Acero King



M930 - Rovere Chiaro



M927 - Rovere Gessato



M951 - Noce Rigato



M912 - Noce Eden

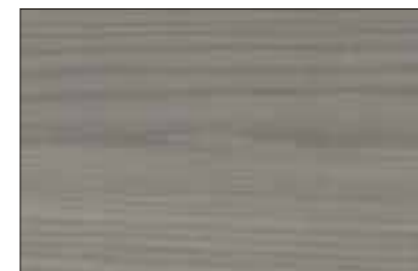

M945 - Frassino Grigio



M931 - Rovere Scuro



M950 - Olmo Scuro

I colori e le finiture qui riportati devono ritenersi puramente indicativi. Per una visione realistica consultare il nostro campionario colori.
 Colours and finishes shown here are merely indicative. Please see our colour samples book for a more realistic image.
 Les coloris et les finitions sont présentés à titre purement indicatif. Pour un rendu réel, consulter notre nuancier.

LACCATO GOFFRATO FINE OPACO

LACQUERED WITH A MATT EMBOSSED FINISH - LAQUÉ MAT GAUFRÉ FIN



F220 - Giallo Sole



F430 - Rosso Rubino



F585 - Verde Mare

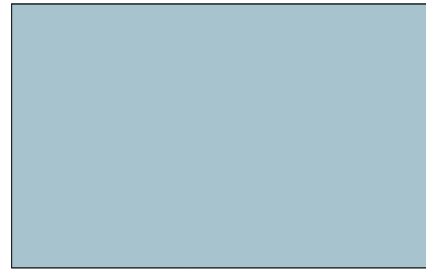

F620 - Azzurro



F680 - Oceano



F570 - Verde Muschio

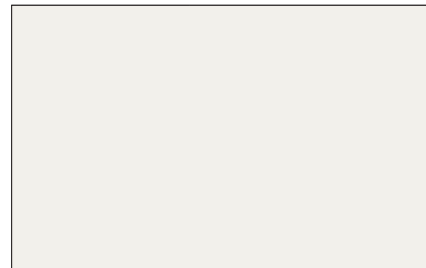

F005 - Bianco Latte

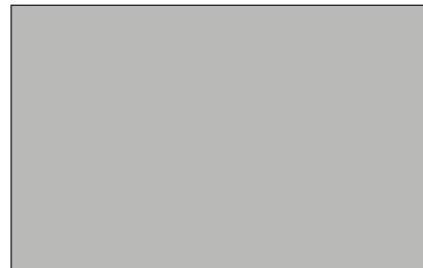

F060 - Grigio Malta

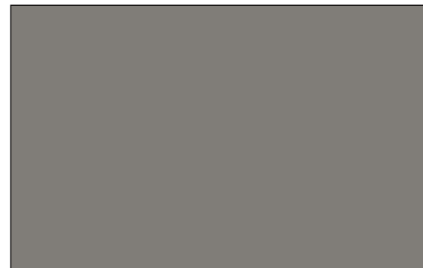

F075 - Grigio Caldo

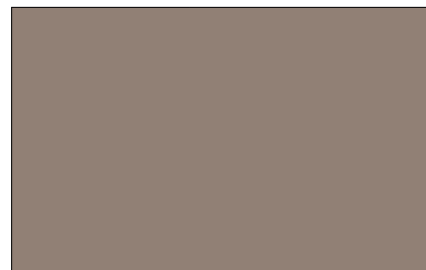

F110 - Gianduia

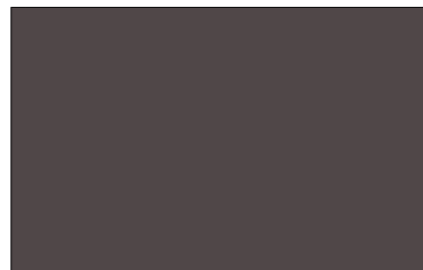

F490 - Fango

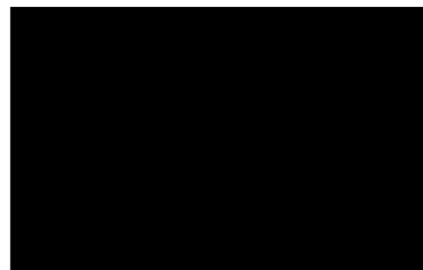

F095 - Nero Intenso

LACCATO LUCIDO SPAZZOLATO

LACQUERED WITH A POLISHED BRUSHED FINISH - LAQUÉ BRILLANT BROSSÉ



K220 - Giallo Sole



K430 - Rosso Rubino



K585 - Verde Mare



K620 - Azzurro



K680 - Oceano



K570 - Verde Muschio

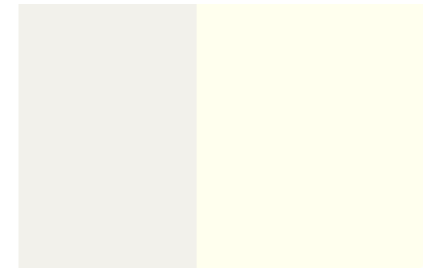

K005 - Bianco Latte



K060 - Grigio Malta



K075 - Grigio Caldo

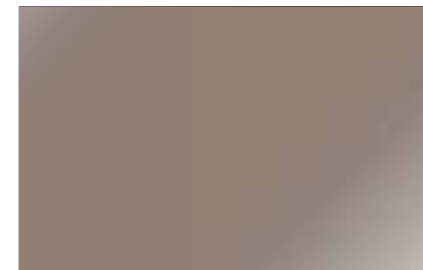

K110 - Gianduia



K490 - Fango

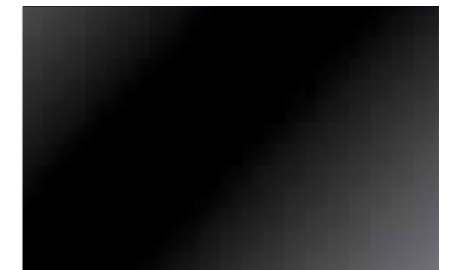

K095 - Nero Intenso

LACCATURE A CAMPIONE (CON MAGGIORAZIONE):

CONTATTARE IL NOSTRO UFFICIO TECNICO COMMERCIALE CHE NE VALUTERÀ FATTIBILITÀ E COSTI

CUSTOMER LACQUERED COLOURS (WITH SURCHARGE):

CHECK FEASIBILITY AND PRICES WITH OUR TECHNICAL SALES OFFICE

LAQUAGE SELON ÉCHANTILLON (AVEC SUPPLÉMENT):

CONTACTER NOTRE BUREAU TECHNICO-COMMERCIAL POUR LA FAISABILITÉ ET LES COÛTS

I colori e le finiture qui riportati devono ritenersi puramente indicativi. Per una visione realistica consultare il nostro campionario colori.
Colours and finishes shown here are merely indicative. Please see our colour samples book for a more realistic image.
Les coloris et les finitions sont présentés à titre purement indicatif. Pour un rendu réel, consulter notre nuancier.

LACCATURE A CAMPIONE (CON MAGGIORAZIONE):

CONTATTARE IL NOSTRO UFFICIO TECNICO COMMERCIALE CHE NE VALUTERÀ FATTIBILITÀ E COSTI

CUSTOMER LACQUERED COLOURS (WITH SURCHARGE):

CHECK FEASIBILITY AND PRICES WITH OUR TECHNICAL SALES OFFICE

LAQUAGE SELON ÉCHANTILLON (AVEC SUPPLÉMENT):

CONTACTER NOTRE BUREAU TECHNICO-COMMERCIAL POUR LA FAISABILITÉ ET LES COÛTS

I colori e le finiture qui riportati devono ritenersi puramente indicativi. Per una visione realistica consultare il nostro campionario colori.
Colours and finishes shown here are merely indicative. Please see our colour samples book for a more realistic image.
Les coloris et les finitions sont présentés à titre purement indicatif. Pour un rendu réel, consulter notre nuancier.

H 2264 ÷ H 2878

PARETE DIVISORIA VERTICALE VERTICAL PARTITION WALL - CLOISON VERTICALE

H 2128 FILO PORTA - WITH DOOR H 2128 - AVEC LA PORTE H 2128

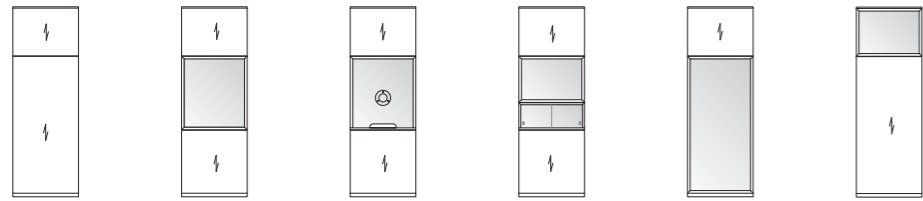

- 9D11P5 L. 500
- 9D11PA L. 1000
- 9D11PD L. 1200
- 9D11PF L. 1500
- 9D21P5 L. 500
- 9D21PA L. 1000
- 9D21PD L. 1200
- 9D21PF L. 1500
- 9D21PH L. 2000
- 9D31PA L. 1000
- 9D31PD L. 1200
- 9D31PF L. 1500
- 9D31PH L. 2000
- 9D41PA L. 1000
- 9D41PD L. 1200
- 9D41PF L. 1500
- 9D61P5 L. 500
- 9D61PA L. 1000
- 9D61PD L. 1200
- 9D61PF L. 1500
- 9D91P5 L. 500
- 9D91PA L. 1000
- 9D91PD L. 1200
- 9D91PF L. 1500

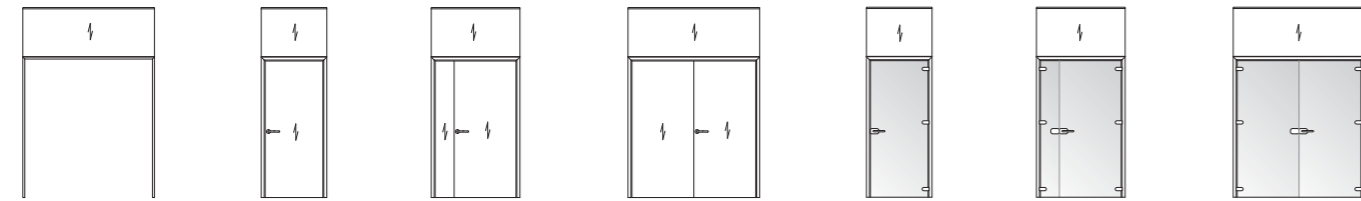

- 9DD1PA L. 1000
- 9DD1PD L. 1200
- 9DD1PH L. 2000
- 9DE1PA L. 1000
- 9DE1PD L. 1200
- 9DE1PE L. 1200
- 9DE1PH L. 2000
- 9DF1PA L. 1000
- 9DF1PD L. 1200
- 9DF1PE L. 1200
- 9DF1PH L. 2000

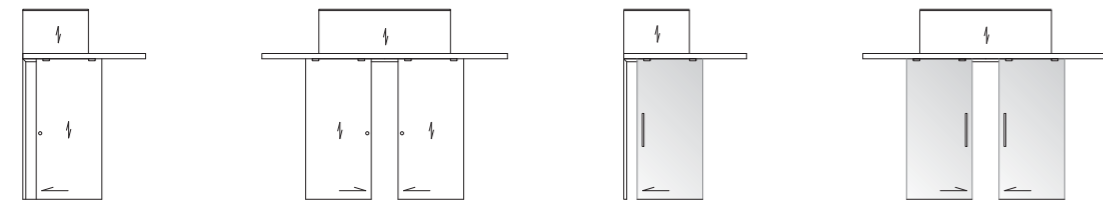

- 9DM1PA L. 1000
- 9DM1PH L. 2000
- 9DN1PA L. 1000
- 9DN1PH L. 2000

H 2544 FILO PORTA - WITH DOOR H 2544 - AVEC LA PORTE H 2544

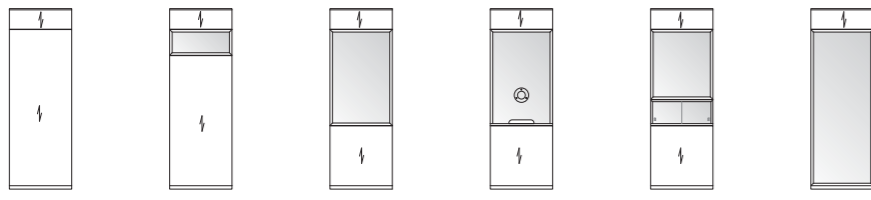

- 9D13P5 L. 500
- 9D13PA L. 1000
- 9D13PD L. 1200
- 9D13PF L. 1500
- 9D83P5 L. 500
- 9D83PA L. 1000
- 9D83PD L. 1200
- 9D83PF L. 1500
- 9D23P5 L. 500
- 9D23PA L. 1000
- 9D23PD L. 1200
- 9D23PF L. 1500
- 9D23PH L. 2000
- 9D33PA L. 1000
- 9D33PD L. 1200
- 9D33PF L. 1500
- 9D33PH L. 2000
- 9D43PA L. 1000
- 9D43PD L. 1200
- 9D43PF L. 1500
- 9D63P5 L. 500
- 9D63PA L. 1000
- 9D63PD L. 1200
- 9D63PF L. 1500

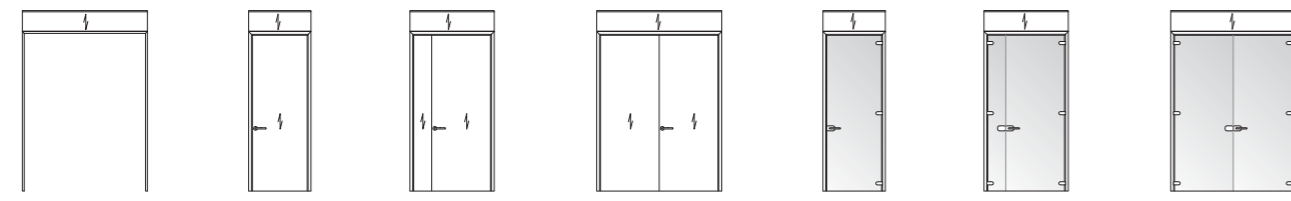

- 9DD3PA L. 1000
- 9DD3PD L. 1200
- 9DD3PH L. 2000
- 9DE3PA L. 1000
- 9DE3PD L. 1200
- 9DE3PE L. 1200
- 9DE3PH L. 2000
- 9DF3PA L. 1000
- 9DF3PD L. 1200
- 9DF3PE L. 1200
- 9DF3PH L. 2000

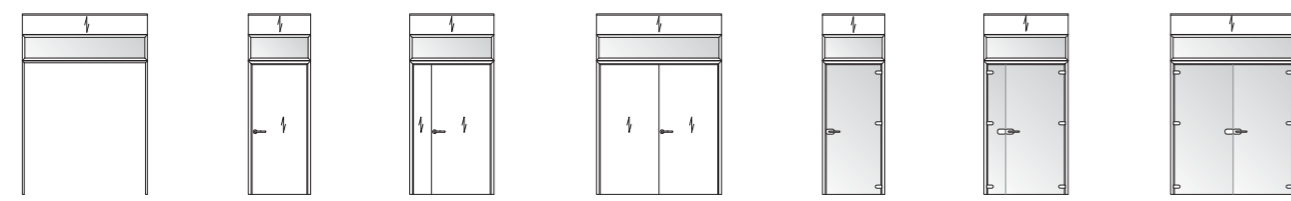

- 9DG0PA L. 1000
- 9DG0PD L. 1200
- 9DG0PH L. 2000
- 9DH0PA L. 1000
- 9DH0PD L. 1200
- 9DHOPE L. 1200
- 9DH0PH L. 2000
- 9DL0PA L. 1000
- 9DL0PD L. 1200
- 9DLOPE L. 1200
- 9DL0PH L. 2000

H 2264 ÷ H 2878

PARETE DIVISORIA VERTICALE VERTICAL PARTITION WALL - CLOISON VERTICALE

H 2544 FILO PORTA - WITH DOOR H 2544 - AVEC LA PORTE H 2544

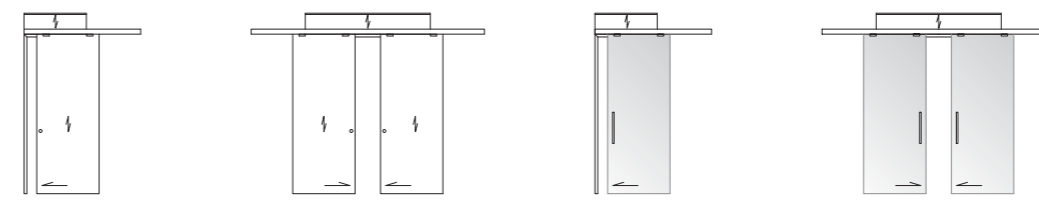

- 9DM3PA L. 1000
- 9DM3PH L. 2000
- 9DN3PA L. 1000
- 9DN3PH L. 2000

H 2878 FILO PORTA A TUTTA ALTEZZA - MODULES WITH FULL HEIGHT DOOR - MODULES AVEC PORTE DANS TOUTE LA HAUTEUR



- 9D00P5 L. 500
- 9D00PA L. 1000
- 9D00PD L. 1200
- 9D00PF L. 1500
- 9D70P5 L. 500
- 9D70PA L. 1000
- 9D70PD L. 1200
- 9D70PF L. 1500
- 9D50P5 L. 500
- 9D50PA L. 1000
- 9D50PD L. 1200
- 9D50PF L. 1500
- 9DA1PA L. 1000
- 9DB1PA L. 1000

H 2879 ÷ H 3294

H 2128 FILO PORTA - WITH DOOR H 2128 - AVEC LA PORTE H 2128

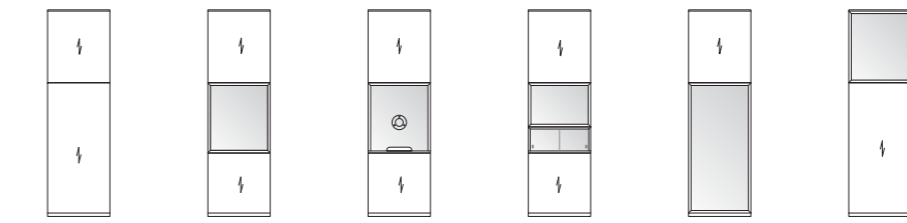

- 9D11R5 L. 500
- 9D11RA L. 1000
- 9D11RD L. 1200
- 9D11RF L. 1500
- 9D21R5 L. 500
- 9D21RA L. 1000
- 9D21RD L. 1200
- 9D21RF L. 1500
- 9D21RH L. 2000
- 9D31RA L. 1000
- 9D31RD L. 1200
- 9D31RF L. 1500
- 9D31RH L. 2000
- 9D41RA L. 1000
- 9D41RD L. 1200
- 9D41RF L. 1500
- 9D61R5 L. 500
- 9D61RA L. 1000
- 9D61RD L. 1200
- 9D61RF L. 1500
- 9D91R5 L. 500
- 9D91RA L. 1000
- 9D91RD L. 1200
- 9D91RF L. 1500

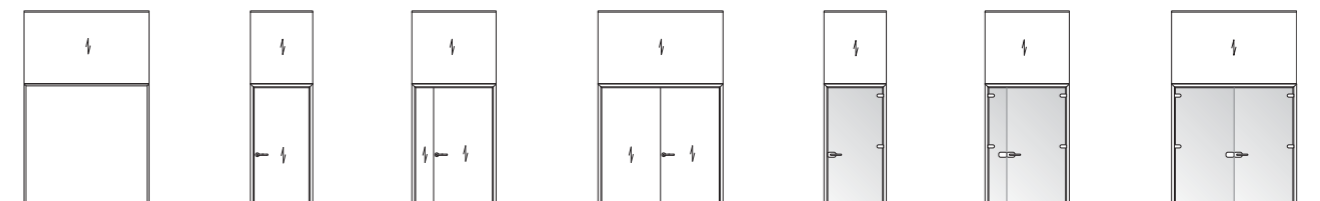

- 9DD1RA L. 1000
- 9DD1RD L. 1200
- 9DD1RH L. 2000
- 9DE1RA L. 1000
- 9DE1RD L. 1200
- 9DE1RE L. 1200
- 9DE1RH L. 2000
- 9DF1RA L. 1000
- 9DF1RD L. 1200
- 9DF1RE L. 1200
- 9DF1RH L. 2000

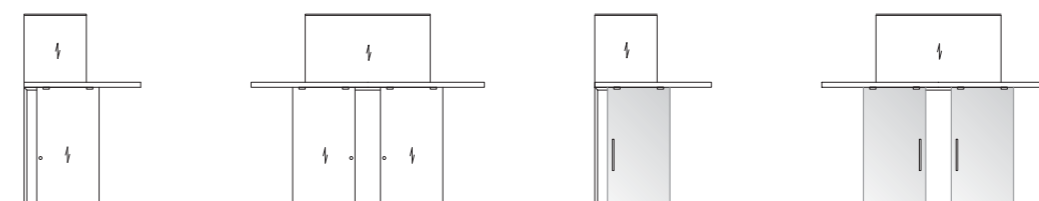

- 9DM1RA L. 1000
- 9DM1RH L. 2000
- 9DN1RA L. 1000
- 9DN1RH L. 2000

H 2879 ÷ H 3294

PARETE DIVISORIA VERTICALE VERTICAL PARTITION WALL - CLOISON VERTICALE

H 2544 FILO PORTA - WITH DOOR H 2544 - AVEC LA PORTE H 2544

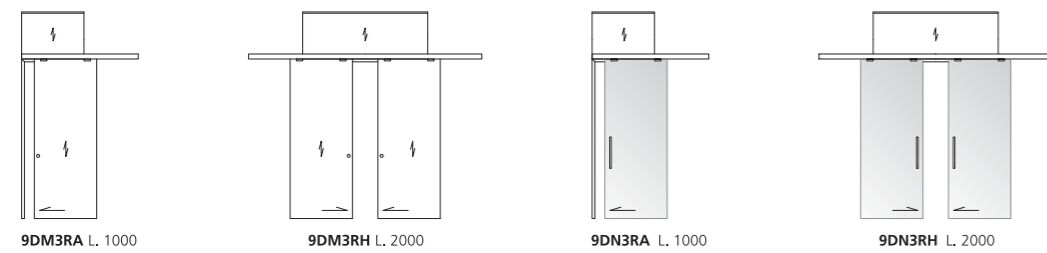
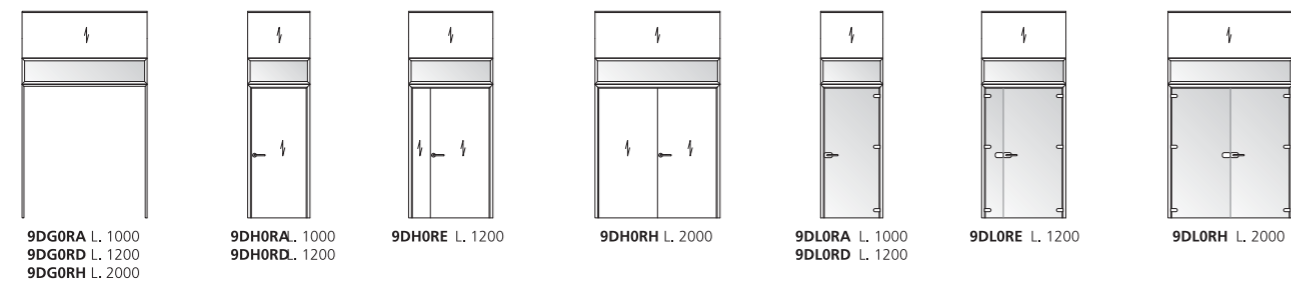
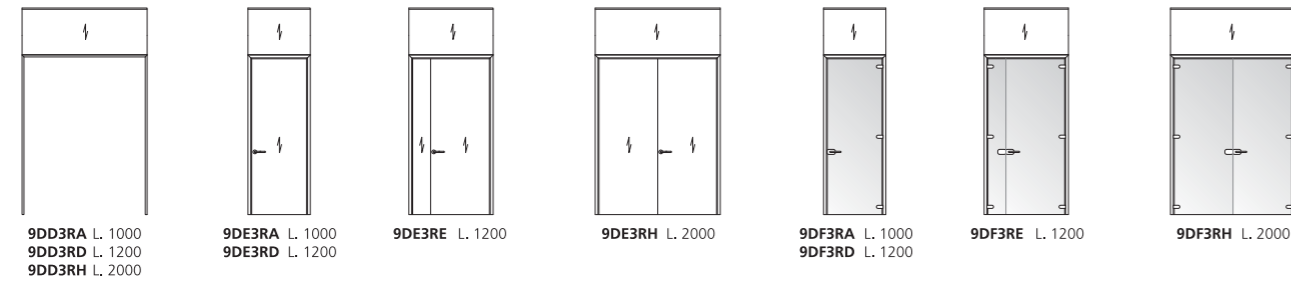
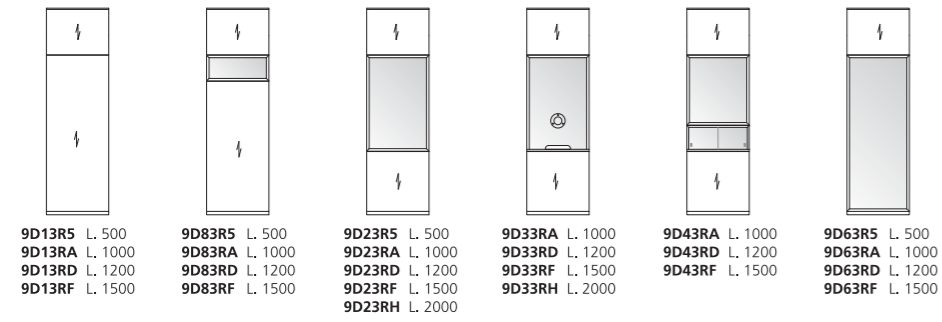

H 3294 FILO PORTA A TUTTA ALTEZZA - MODULES WITH FULL HEIGHT DOOR - AVEC PORTE DANS TOUTE LA HAUTEUR

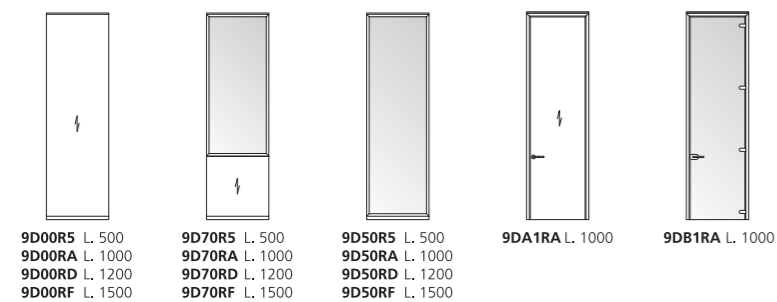

H 3295 ÷ H 3710

PARETE DIVISORIA VERTICALE VERTICAL PARTITION WALL - CLOISON VERTICALE

H 2544 FILO PORTA - WITH DOOR H 2544 - AVEC LA PORTE H 2544

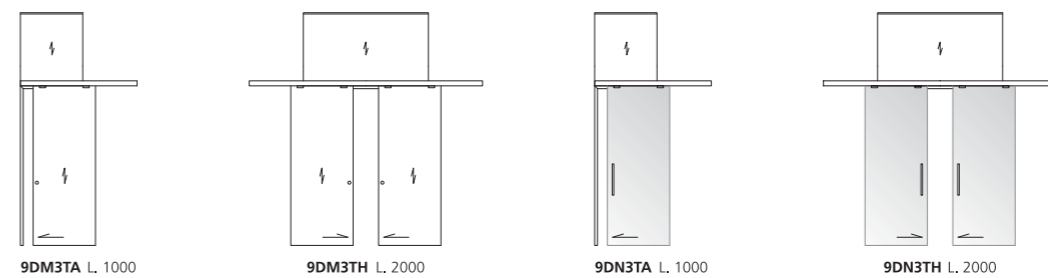
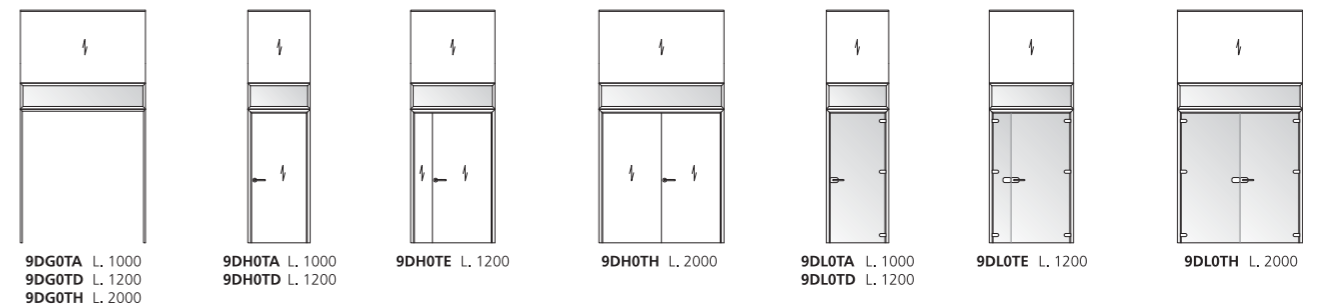
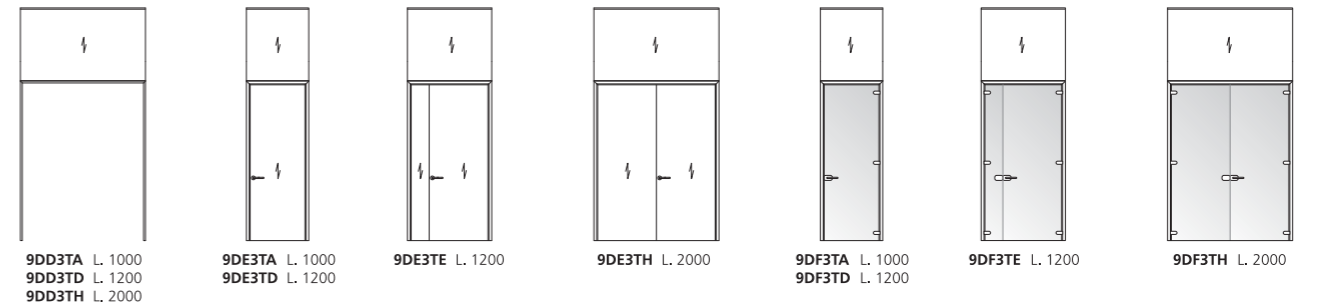
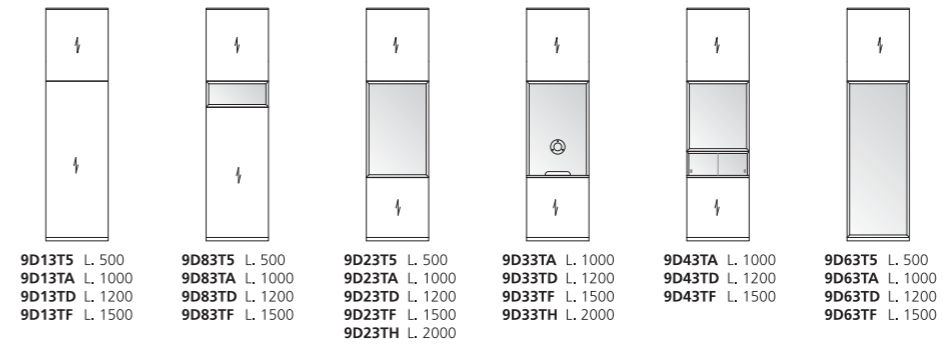

H 2680 ÷ H 2878

PARETE DIVISORIA ORIZZONTALE HORIZONTAL PARTITION WALL - CLOISON HORIZONTALE

H 2128 FILO PORTA - WITH DOOR H 2128 - AVEC LA PORTE H 2128

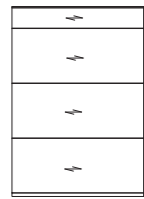

9E13P5 L. 500
9E13PA L. 1000
9E13PF L. 1500
9E13PH L. 2000
9E13PL L. 2500



9E23P5 L. 500
9E23PA L. 1000
9E23PF L. 1500
9E23PH L. 2000
9E23PL L. 2500



9E33P5 L. 500
9E33PA L. 1000
9E33PF L. 1500
9E33PH L. 2000
9E33PL L. 2500



9E43P5 L. 500
9E43PA L. 1000
9E43PF L. 1500
9E43PH L. 2000
9E43PL L. 2500

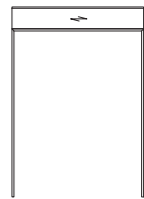

9ED3PA L. 1000
9ED3PD L. 1200
9ED3PH L. 2000

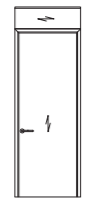

9EE3PA L. 1000
9EE3PD L. 1200

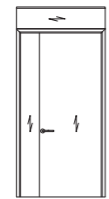

9EE3PE L. 1200

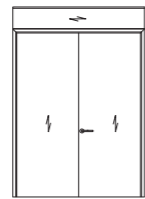

9EE3PH L. 2000



9EF3PA L. 1000
9EF3PD L. 1200



9EF3PE L. 1200



9EF3PH L. 2000

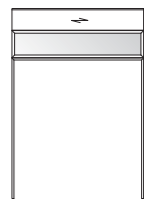

9EG3PA L. 1000
9EG3PD L. 1200
9EG3PH L. 2000

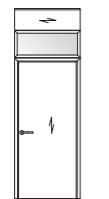

9EH3PA L. 1000
9EH3PD L. 1200



9EH3PE L. 1200



9EH3PH L. 2000



9EL3PA L. 1000
9EL3PD L. 1200

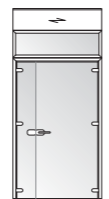

9EL3PE L. 1200



9EL3PH L. 2000

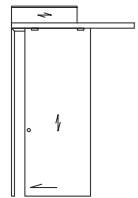

9EM3PA L. 1000

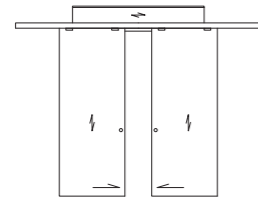

9EM3PH L. 2000



9EN3PA L. 1000

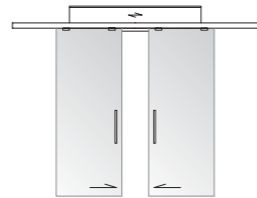

9EN3PH L. 2000

H 2879 ÷ H 3294

PARETE DIVISORIA ORIZZONTALE HORIZONTAL PARTITION WALL - CLOISON HORIZONTALE

H 2544 FILO PORTA - WITH DOOR H 2544 - AVEC LA PORTE H 2544

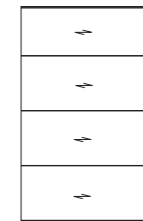

9E13R5 L. 500
9E13RA L. 1000
9E13RF L. 1500
9E13RH L. 2000
9E13RL L. 2500



9E23R5 L. 500
9E23RA L. 1000
9E23RF L. 1500
9E23RH L. 2000
9E23RL L. 2500

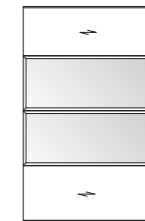

9E33R5 L. 500
9E33RA L. 1000
9E33RF L. 1500
9E33RH L. 2000
9E33RL L. 2500



9E43R5 L. 500
9E43RA L. 1000
9E43RF L. 1500
9E43RH L. 2000
9E43RL L. 2500

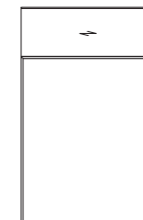

9ED3RA L. 1000
9ED3RD L. 1200
9ED3RH L. 2000

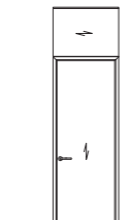

9EE3RA L. 1000
9EE3RD L. 1200

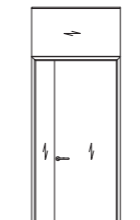

9EE3RE L. 1200

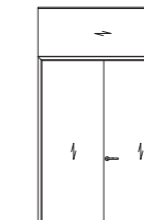

9EE3RH L. 2000



9EF3RA L. 1000
9EF3RD L. 1200

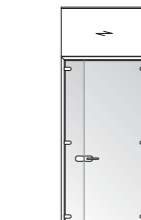

9EF3RE L. 1200

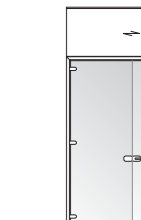

9EF3RH L. 2000

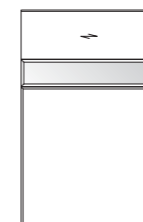

9EG3RA L. 1000
9EG3RD L. 1200
9EG3RH L. 2000

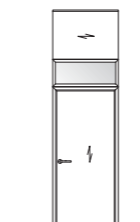

9EH3RA L. 1000
9EH3RD L. 1200

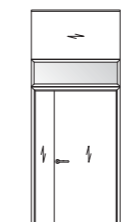

9EH3RE L. 1200

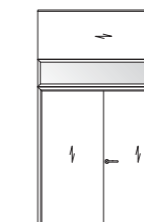

9EH3RH L. 2000



9EL3RA L. 1000
9EL3RD L. 1200



9EL3RE L. 1200

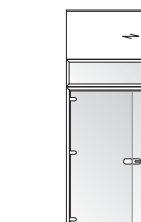

9EL3RH L. 2000

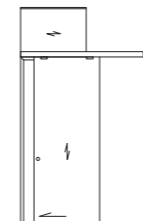

9EM3RA L. 1000

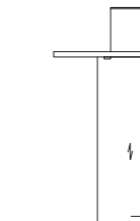

9EM3RH L. 2000

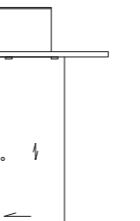

9EN3RA L. 1000

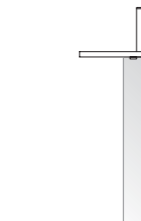

9EN3RH L. 2000

H 3295 ÷ H 3710

PARETE DIVISORIA ORIZZONTALE HORIZONTAL PARTITION WALL - CLOISON HORIZONTALE

H 2544 FILO PORTA - WITH DOOR H 2544 - AVEC LA PORTE H 2544

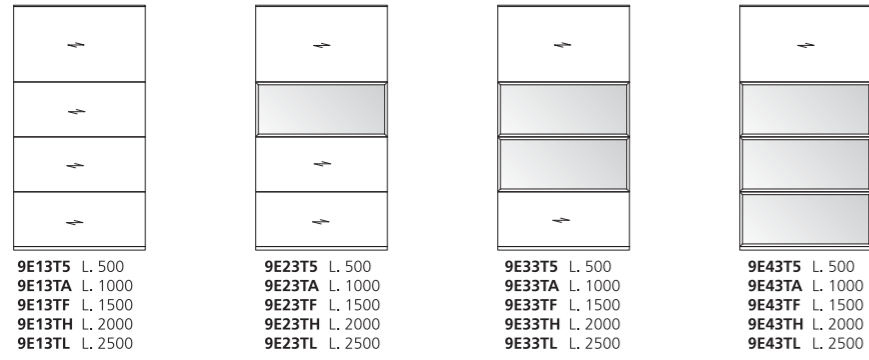

9E13T5 L. 500
9E13TA L. 1000
9E13TF L. 1500
9E13TH L. 2000
9E13TL L. 2500
9E23T5 L. 500
9E23TA L. 1000
9E23TF L. 1500
9E23TH L. 2000
9E23TL L. 2500
9E33T5 L. 500
9E33TA L. 1000
9E33TF L. 1500
9E33TH L. 2000
9E33TL L. 2500
9E43T5 L. 500
9E43TA L. 1000
9E43TF L. 1500
9E43TH L. 2000
9E43TL L. 2500

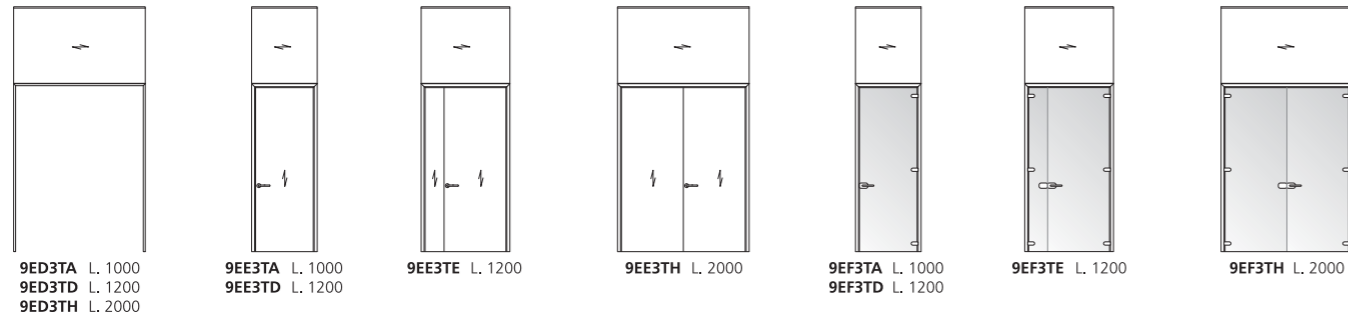

9ED3TA L. 1000
9ED3TD L. 1200
9ED3TH L. 2000
9EE3TA L. 1000
9EE3TD L. 1200
9EE3TE L. 1200
9EE3TH L. 2000
9EF3TA L. 1000
9EF3TD L. 1200
9EF3TE L. 1200
9EF3TH L. 2000

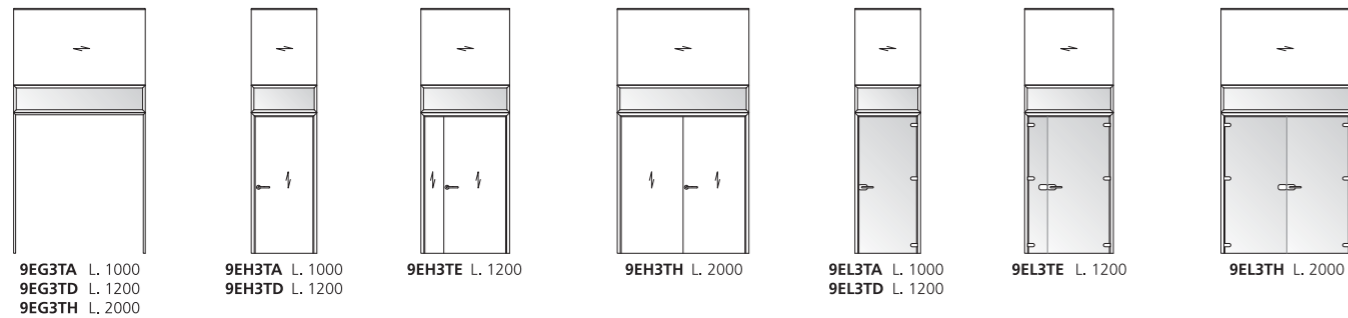

9EG3TA L. 1000
9EG3TD L. 1200
9EG3TH L. 2000
9EH3TA L. 1000
9EH3TD L. 1200
9EH3TE L. 1200
9EH3TH L. 2000
9EL3TA L. 1000
9EL3TD L. 1200
9EL3TE L. 1200
9EL3TH L. 2000



9EM3TA L. 1000
9EM3TH L. 2000
9EN3TA L. 1000
9EN3TH L. 2000

H 2264 ÷ H 2878

PARETE ATTREZZATA MONOFACCIALE WALL MOUNTED STORAGE WALL - CLOISON ÉQUIPÉE MONOFAÇE

H 2128 FILO PORTA - WITH DOOR H 2128 - AVEC LA PORTE H 2128

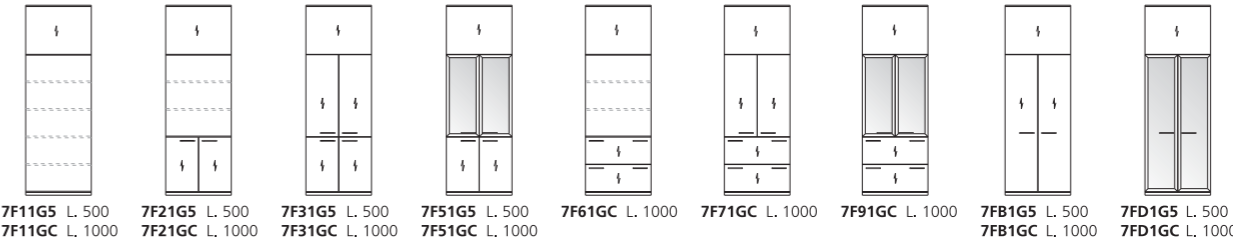

7F11G5 L. 500
7F11GC L. 1000
7F21G5 L. 500
7F21GC L. 1000
7F31G5 L. 500
7F31GC L. 1000
7F51G5 L. 500
7F51GC L. 1000
7F61GC L. 1000
7F71GC L. 1000
7F91GC L. 1000
7FB1G5 L. 500
7FB1GC L. 1000
7FD1G5 L. 500
7FD1GC L. 1000

H 2544 FILO PORTA - WITH DOOR H 2544 - AVEC LA PORTE H 2544

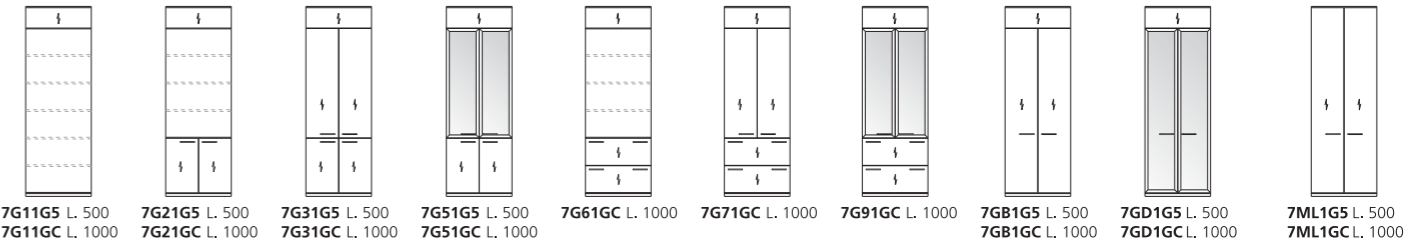

7G11G5 L. 500
7G11GC L. 1000
7G21G5 L. 500
7G21GC L. 1000
7G31G5 L. 500
7G31GC L. 1000
7G51G5 L. 500
7G51GC L. 1000
7G61GC L. 1000
7G71GC L. 1000
7G91GC L. 1000
7GB1G5 L. 500
7GB1GC L. 1000
7GD1G5 L. 500
7GD1GC L. 1000
7ML1G5 L. 500
7ML1GC L. 1000

H 2879 ÷ H 3294

H 2128 FILO PORTA - WITH DOOR H 2128 - AVEC LA PORTE H 2128

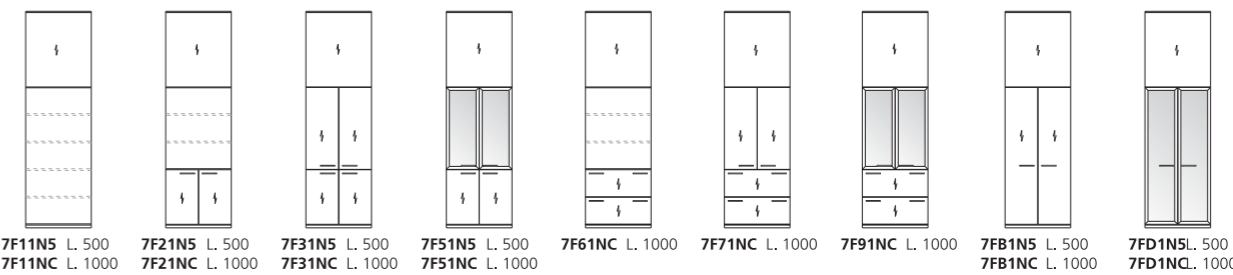

7F11N5 L. 500
7F11NC L. 1000
7F21N5 L. 500
7F21NC L. 1000
7F31N5 L. 500
7F31NC L. 1000
7F51N5 L. 500
7F51NC L. 1000
7F61NC L. 1000
7F71NC L. 1000
7F91NC L. 1000
7FB1N5 L. 500
7FB1NC L. 1000
7FD1N5 L. 500
7FD1NC L. 1000

H 2544 FILO PORTA - WITH DOOR H 2544 - AVEC LA PORTE H 2544

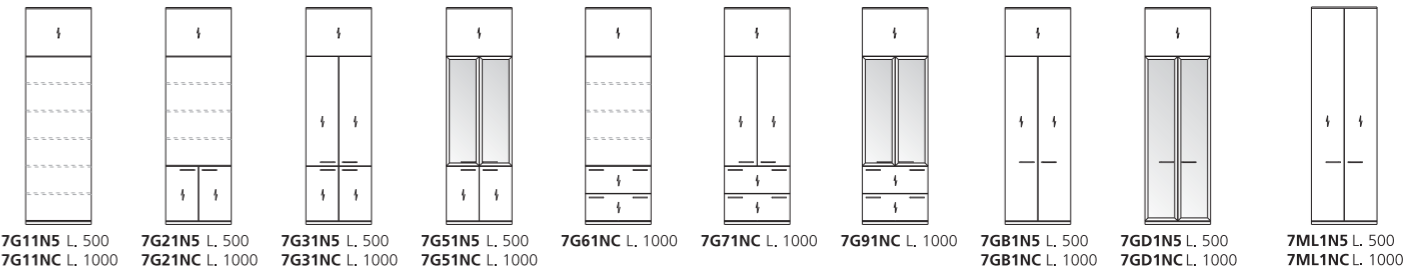

7G11N5 L. 500
7G11NC L. 1000
7G21N5 L. 500
7G21NC L. 1000
7G31N5 L. 500
7G31NC L. 1000
7G51N5 L. 500
7G51NC L. 1000
7G61NC L. 1000
7G71NC L. 1000
7G91NC L. 1000
7GB1N5 L. 500
7GB1NC L. 1000
7GD1N5 L. 500
7GD1NC L. 1000
7ML1N5 L. 500
7ML1NC L. 1000

H 3295 ÷ H 3710

H 2544 FILO PORTA - WITH DOOR H 2544 - AVEC LA PORTE H 2544

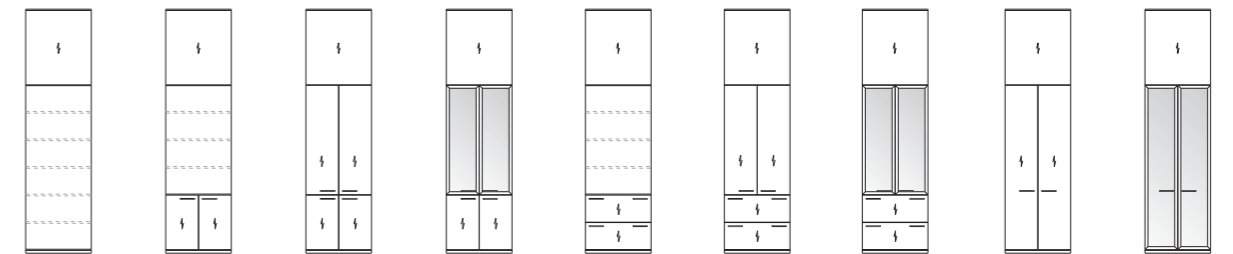

7G11P5 L. 500
7G11PC L. 1000
7G21P5 L. 500
7G21PC L. 1000
7G31P5 L. 500
7G31PC L. 1000
7G51P5 L. 500
7G51PC L. 1000
7G61PC L. 1000
7G71PC L. 1000
7G91PC L. 1000
7GB1P5 L. 500
7GB1PC L. 1000
7GD1P5 L. 500
7GD1PC L. 1000

H 2264 ÷ H 2878

PARETE ATTREZZATA BIFACCIALE CENTRAL STORAGE WALL - CLOISON ÉQUIPÉE BIFACE

H 2128 FILO PORTA - WITH DOOR H 2128 - AVEC LA PORTE H 2128

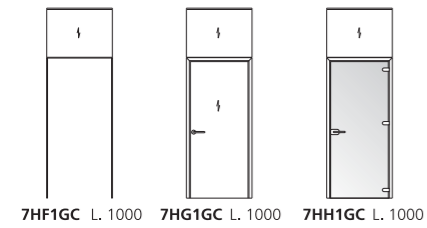
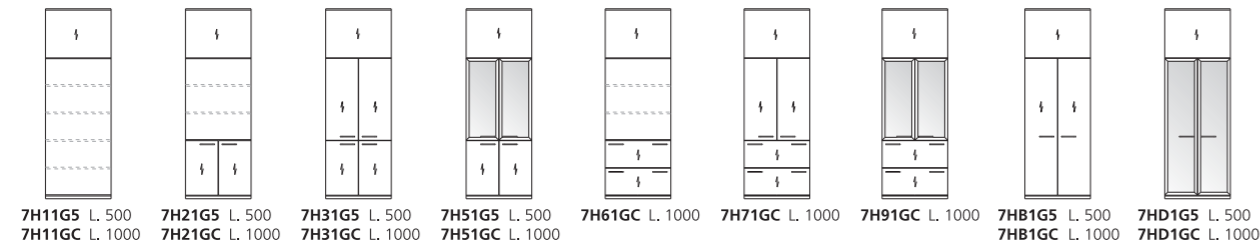

H 2544 FILO PORTA - WITH DOOR H 2544 - AVEC LA PORTE H 2544

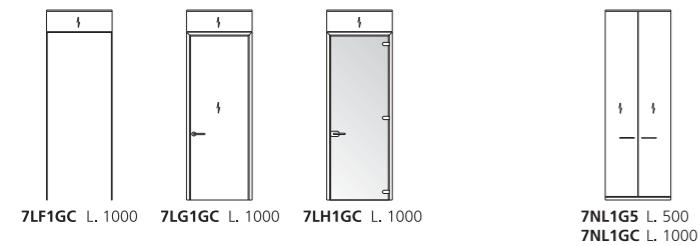
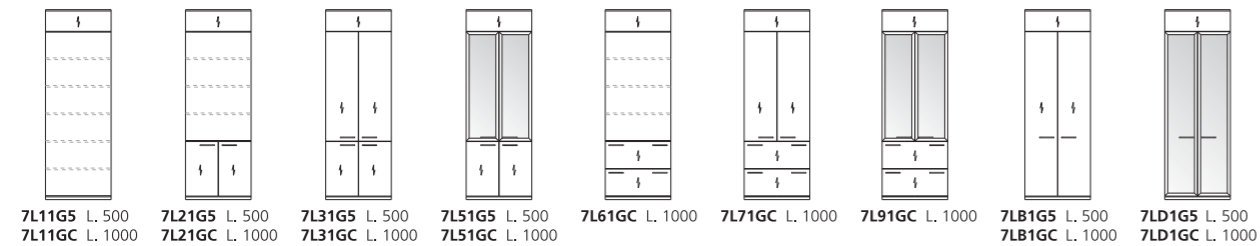

H 2879 ÷ H 3294

H 2128 FILO PORTA - WITH DOOR H 2128 - AVEC LA PORTE H 2128

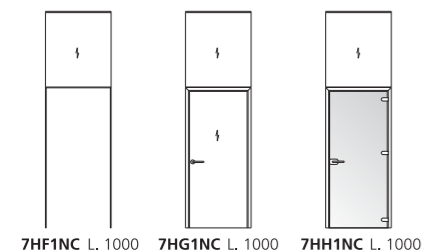
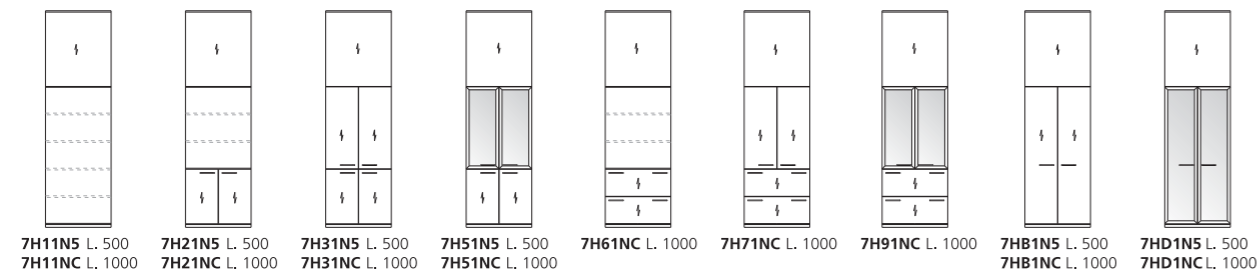

H 2879 ÷ H 3294

PARETE ATTREZZATA BIFACCIALE CENTRAL STORAGE WALL - CLOISON ÉQUIPÉE BIFACE

H 2544 FILO PORTA - WITH DOOR H 2544 - AVEC LA PORTE H 2544

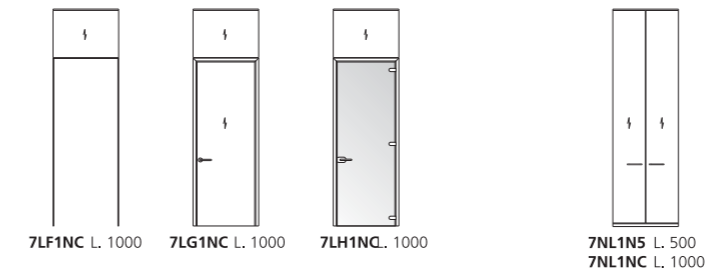
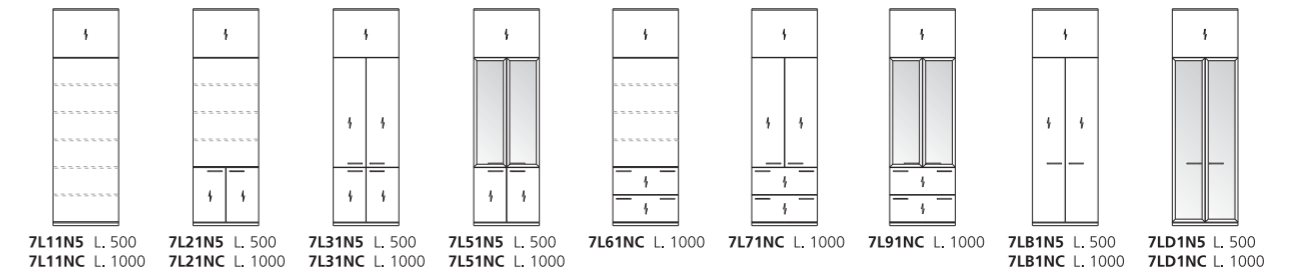

H 3295 ÷ H 3710

H 2544 FILO PORTA - WITH DOOR H 2544 - AVEC LA PORTE H 2544

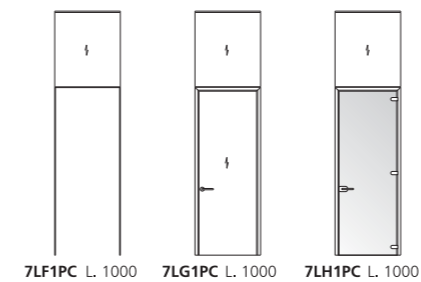
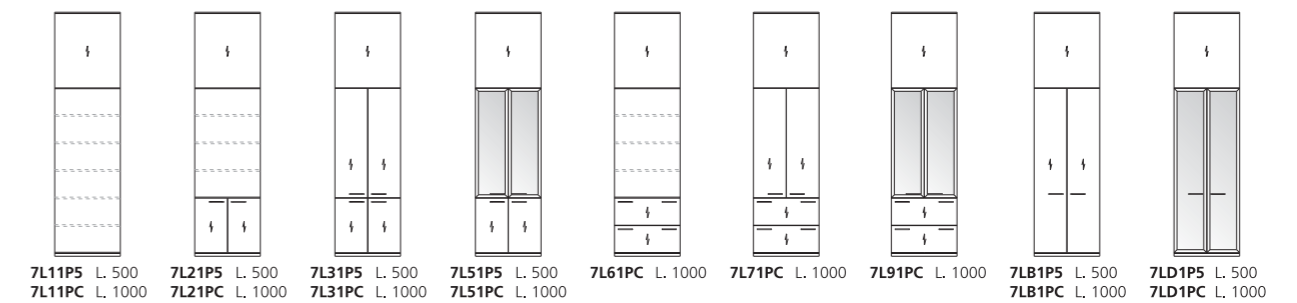

H 694

CONTENTORI MONOFACCIALI WALL MOUNTED STORAGE UNITS - RANGEMENTS MONOFACES



7D1135 L. 500 P. 441
7D113C L. 1000 P. 441
7D1335 L. 500 P. 569
7D133C L. 1000 P. 569



7D2135 L. 500 P. 461
7D213C L. 1000 P. 461
7D2335 L. 500 P. 589
7D233C L. 1000 P. 589

H 886



7D1155 L. 500 P. 441
7D115C L. 1000 P. 441
7D1355 L. 500 P. 569
7D135C L. 1000 P. 569



7D2155 L. 500 P. 461
7D215C L. 1000 P. 461
7D2355 L. 500 P. 589
7D235C L. 1000 P. 589



7D315C L. 1000 P. 461
7D335C L. 1000 P. 589



7D415C L. 1000 P. 461
7D435C L. 1000 P. 589



7D6155 L. 500 P. 461
7D615C L. 1000 P. 461
7D6355 L. 500 P. 589
7D635C L. 1000 P. 589

H 1302



7D1175 L. 500 P. 441
7D117C L. 1000 P. 441
7D1375 L. 500 P. 569
7D137C L. 1000 P. 569



7D8175 L. 500 P. 461
7D817C L. 1000 P. 461
7D8375 L. 500 P. 589
7D837C L. 1000 P. 589



7D917C L. 1000 P. 461
7D937C L. 1000 P. 589



7D2175 L. 500 P. 461
7D217C L. 1000 P. 461
7D2375 L. 500 P. 589
7D237C L. 1000 P. 589



7D6175 L. 500 P. 461
7D617C L. 1000 P. 461
7D6375 L. 500 P. 589
7D637C L. 1000 P. 589

H 1718



7D1195 L. 500 P. 441
7D119C L. 1000 P. 441
7D1395 L. 500 P. 569
7D139C L. 1000 P. 569



7D8195 L. 500 P. 461
7D819C L. 1000 P. 461
7D8395 L. 500 P. 589
7D839C L. 1000 P. 589



7D919C L. 1000 P. 461
7D939C L. 1000 P. 589



7D2195 L. 500 P. 461
7D219C L. 1000 P. 461
7D2395 L. 500 P. 589
7D239C L. 1000 P. 589



7D6195 L. 500 P. 461
7D619C L. 1000 P. 461
7D6395 L. 500 P. 589
7D639C L. 1000 P. 589

H 2134

H 2128 FILO PORTA - WITH DOOR H 2128 - AVEC LA PORTE H 2128



7D11A5 L. 500 P. 441
7D11AC L. 1000 P. 441
7D13A5 L. 500 P. 569
7D13AC L. 1000 P. 569



7D81A5 L. 500 P. 461
7D81AC L. 1000 P. 461
7D83A5 L. 500 P. 589
7D83AC L. 1000 P. 589



7D91A5 L. 500 P. 461
7D91AC L. 1000 P. 461
7D93A5 L. 500 P. 589
7D93AC L. 1000 P. 589



7DD1A5 L. 500 P. 461
7DD1AC L. 1000 P. 461
7DD3A5 L. 500 P. 589
7DD3AC L. 1000 P. 589



7D91AC L. 1000 P. 461
7D93AC L. 1000 P. 589



7DF1AC L. 1000 P. 461
7DF3AC L. 1000 P. 589



7DH1AC L. 1000 P. 461
7DH3AC L. 1000 P. 589



7D21A5 L. 500 P. 461
7D21AC L. 1000 P. 461
7D23A5 L. 500 P. 589
7D23AC L. 1000 P. 589



7D61A5 L. 500 P. 461
7D61AC L. 1000 P. 461
7D63A5 L. 500 P. 589
7D63AC L. 1000 P. 589

H 2550

CONTENTORI MONOFACCIALI WALL MOUNTED STORAGE UNITS - RANGEMENTS MONOFACES

H 2544 FILO PORTA - WITH DOOR H 2544 - AVEC LA PORTE H 2544



7D11C5 L. 500 P. 441
7D11CC L. 1000 P. 441
7D13C5 L. 500 P. 569
7D13CC L. 1000 P. 569



7D81C5 L. 500 P. 461
7D81CC L. 1000 P. 461
7D83C5 L. 500 P. 589
7D83CC L. 1000 P. 589



7DB1C5 L. 500 P. 461
7DB1CC L. 1000 P. 461
7DB3C5 L. 500 P. 589
7DB3CC L. 1000 P. 589



7DD1C5 L. 500 P. 461
7DD1CC L. 1000 P. 461
7DD3C5 L. 500 P. 589
7DD3CC L. 1000 P. 589



7D91CC L. 1000 P. 461
7D93CC L. 1000 P. 589



7DF1CC L. 1000 P. 461
7DF3CC L. 1000 P. 589



7DH1CC L. 1000 P. 461
7DH3CC L. 1000 P. 589



7D21C5 L. 500 P. 461
7D21CC L. 1000 P. 461
7D23C5 L. 500 P. 589
7D23CC L. 1000 P. 589



7D61C5 L. 500 P. 461
7D61CC L. 1000 P. 461
7D63C5 L. 500 P. 589
7D63CC L. 1000 P. 589

H 694

CONTENTORI BIFACCIALI CENTRAL STORAGE UNITS - RANGEMENTS BIFACES



7E1135 L. 500 P. 446
7E113C L. 1000 P. 446



7E2135 L. 500 P. 466
7E213C L. 1000 P. 466

H 886



7E1155 L. 500 P. 446
7E115C L. 1000 P. 446



7E2155 L. 500 P. 466
7E215C L. 1000 P. 466



7E315C L. 1000 P. 466



7E6155 L. 500 P. 466
7E615C L. 1000 P. 466

H 1302



7E1175 L. 500 P. 446
7E117C L. 1000 P. 446



7E8175 L. 500 P. 466
7E817C L. 1000 P. 466



7E917C L. 1000 P. 466



7E2175 L. 500 P. 466
7E217C L. 1000 P. 466



7E6175 L. 500 P. 466
7E617C L. 1000 P. 466

H 1718



7E1195 L. 500 P. 446
7E119C L. 1000 P. 446



7E8195 L. 500 P. 466
7E819C L. 1000 P. 466



7E919C L. 1000 P. 466



7E2195 L. 500 P. 466
7E219C L. 1000 P. 466



7E6195 L. 500 P. 466
7E619C L. 1000 P. 466

LOGICA

WALCO
OFFICE FURNITURE

WALCO Spa

Via dei Cavalli, 9 - 31030 Cison di Valmarino (TV) - Italy

T. +39 0438 975666 - F. +39 0438 975656

walco@walco-office.it - www.walco-office.it